



Product Catalog

Dispositivos Flexibles S.A. de C.V.



Calle 1 Norte, No. 3 Col. Atenatitlan, Jiutepec, Mor. México C.P. 62572
Tel: 01 (777) 319 4506 / 320 5767
Fax: 320 2680
Dispositivosflexibles@hotmail.com
www.dispoflex.com.mx

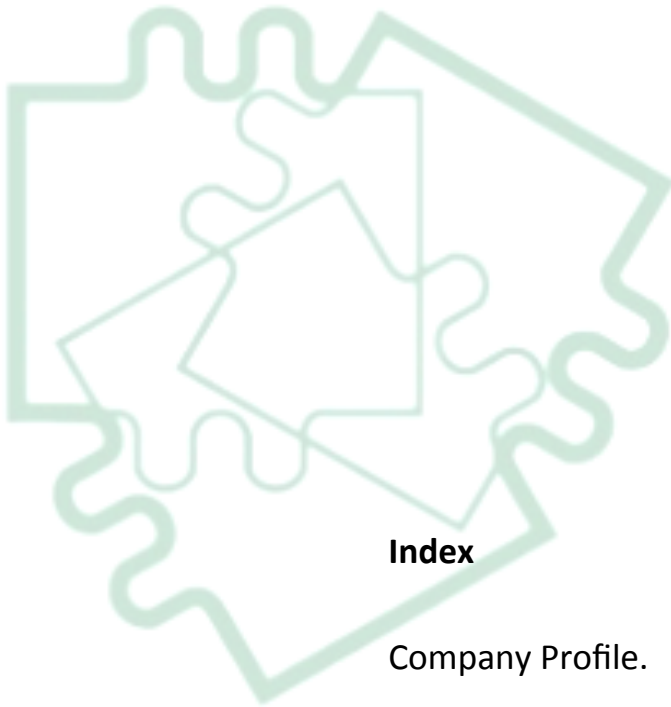

Index

Company Profile.

Metallic Expansion Joints.

Elastomeric Expansion Joints.

Textile Expansion Joints.

Flexible Metal Hoses.

About Us

Dispositivos Flexibles S.A. de C.V. is dedicated to the manufacturing, design and marketing of Metallic and Elastomeric Expansion Joints, as well as products related to flexibility, operation and maintenance of industrial pipe systems.

With over 25 years of experience, which proof our quality and excellence, we serve a wide range of clients, providing them with complete technical solutions for industries that require so.

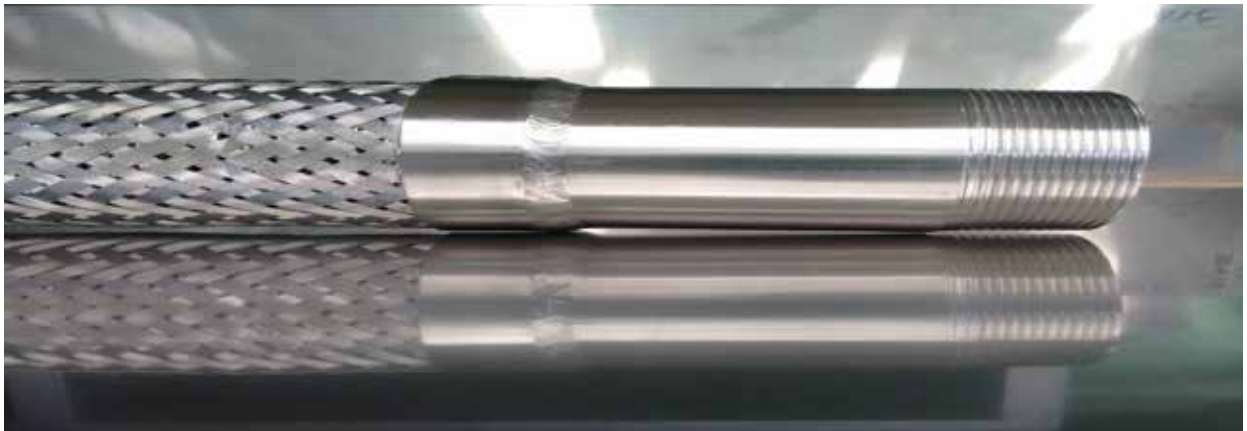

History



Dispositivos Flexibles, S.A. de C.V. was founded on November 28, 1990 by specialist in the field of design and manufacturing of products in the industry and has ever since grown with professional experience that only time can provide.

Our plant has the capacity to produce all types of metallic and rubber joints as well as related products. The great amount of satisfied clients speaks of our professionalism and quality.

Our staff is highly qualified and advises professionally industries that require our services and count with all the necessary recourses to carry out any activity in our field of action.

We work according to codes: EJMA (Expansion Joint Manufacturers Association), ASME SECCION VIII Division 1 and FSA (Fluid Sealing Association).

Calle 1 Norte, No. 3 Col. Atenatitlán, Jiutepec, Mor. Tel: (777) 319 45 06/ 320 57 67
dispositivosflexibles@hotmail.com www.dispoflex.com.mx

Mission and Vision

Mission

To be the leading company in design, manufacturing and marketing of Expansion Joints, satisfying our clients' needs by offering them high quality products and professionals and trustworthy service and in this manner offering a constant growth of the company and professional development of its employees.

Vision

To be the major providing company of trust for our clients regarding the products offered such as the Metallic and Elastomeric Expansion Joints, flexible metallic hoses and compensators, as far as quality, opportunity of delivery, price and service, as well as being competitive and innovative in the development of our country.

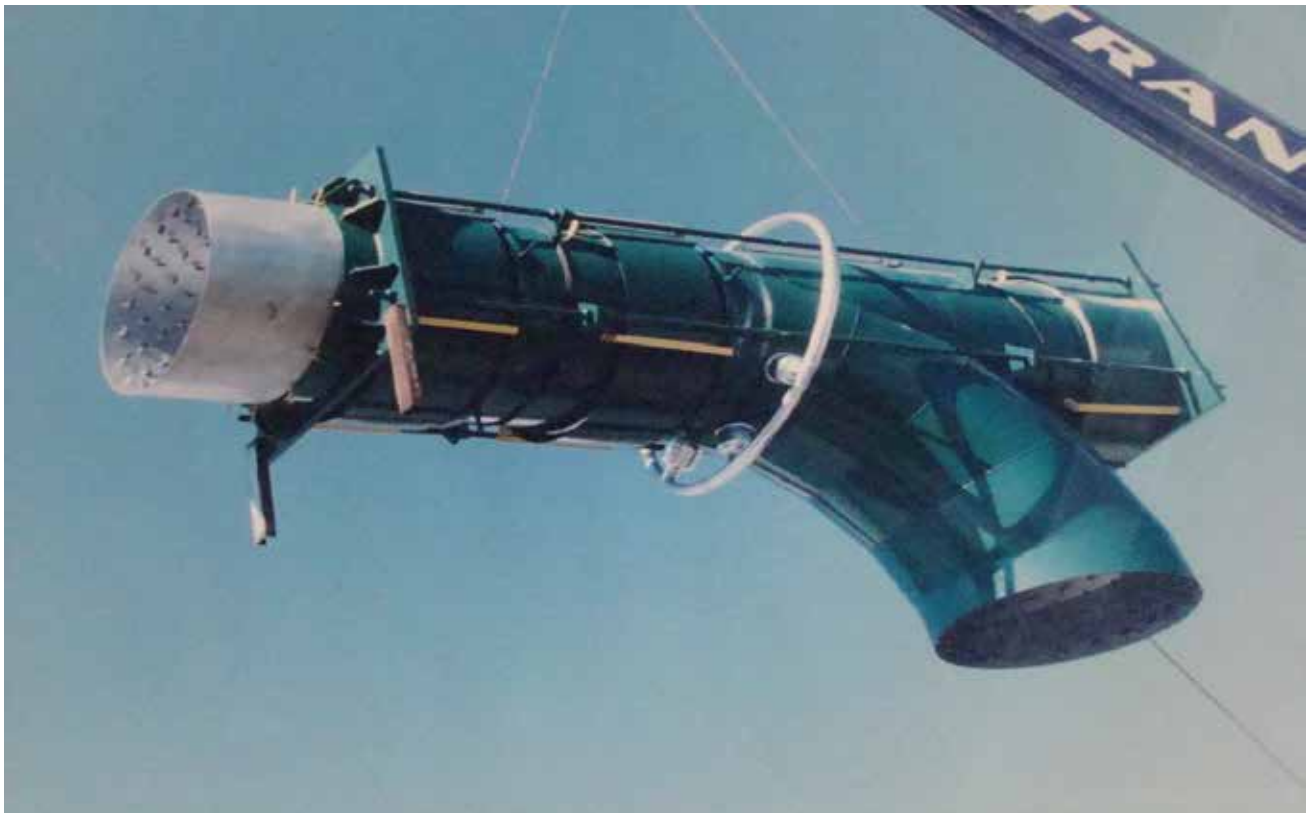

Corporate Values

Our values define the character of our company as well as the products and services offered by our brand and together with our mission and vision guide and distinguish us.

Our company is based on the following values:

- **Integrity**

We act with respect, honesty and dedication towards any person or organization with whom we interact, being our clients, providers, partners or employees. Each and every one of them provides and receives a deserving and professional treatment.



- **Team work**

To achieve our goals and objectives successfully, it is of upmost importance that collaboration and teamwork are a part in the search of excellence.

Corporate Values



- **Communication**

Communication is a fundamental factor to allow the functioning of any organization and to achieve an effective communication it is necessary to establish feedback; both should flow freely in all levels of the company with internal personnel as well as clients and providers.

- **The search of Excellence**

Day after day one can learn something new, that can help to improve and getting closer to excellence in our products and services. This allows us to completely satisfy our clients' demands and consolidate our participation in the market of new tendencies and future planning.





Commitment to our clients

Dispositivos Flexibles S.A. de C.V. commits to listen attend, identify and collaborate in the search of solutions that satisfy your needs. Through a personalized and direct treatment our trained personnel offers you professional service of quality and expresses the commitment to you, receiving fidelity and mutual trust.

Quality policies

At Dispositivos Flexibles S.A. de C.V. we are looking to satisfy the needs of our clients, offering always the quality and professionalism that characterizes us.

The search of excellence through continuous improvement is the foundation of who we are and what we want to offer the industry. A better product and service to our clients.



DISPOFLEX

Dispositivos Flexibles S.A. de C.V. Metallic Expansion Joints



DISPOFLEX

Dispositivos Flexibles S.A. de C.V.

Product Catalog

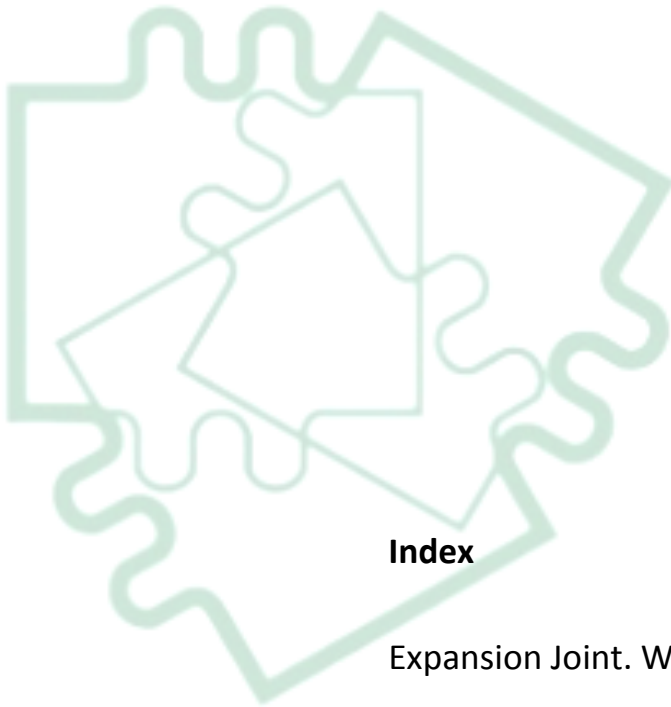

Index

Expansion Joint. What is an expansion joint?

Types of Movement.

Metallic Expansion Joints.

Types of Metallic Expansion Joints.

Rectangular Expansion Joints.

Accessories for Metallic Expansion Joints.

Positioning of pipe guides.

Thermal Expansion of the pipe in inches by 100 feet.

Expansion Joint

What is an expansion joint?

When designing, producing and maintaining industrial pipe systems, different situations have to be taken into account. Such situations can be mechanical movements, vibrations, misalignments in pipes or movement caused by thermal expansion. All of these movements in the pipe are transmitted to the mounting and equipment connected to them, provoking deformations, failure and ruptures in the systems, which can lead to pricy production stops.

There are different ways to attack this situation, being the correct use of Expansion Joints in the pipes one of the most effective ones.



Expansion Joints are flexible devices designed to absorb movements generated by the pipe system because of variations in temperature and pressures. By absorbing those movements, the joints reduce the mechanical vibration caused by other equipment and diminishes the noise of the pipes.

The essential part of an Expansion Joint, which allows the movement and flexibility, is the bellow. The bellow requires to be very resistant to support the pressure of the fluids handled, but also flexible enough to absorb the present movements such as axial, lateral, angular, rotations and vibrations.



Types of Movement

Basic movements that can exist in an Expansion Joint are:

Axial movement that can be of *compression* or *extension*, **lateral** movement and **angular** movement.

One can also find **rotational** and **vibratory** movement.

Neutral Bellow

Under any pressure or temperature.

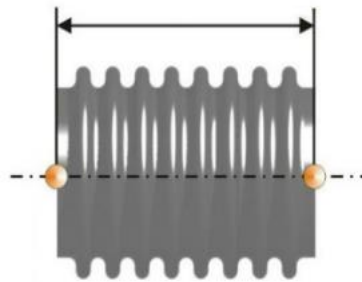

Axial movement to compression

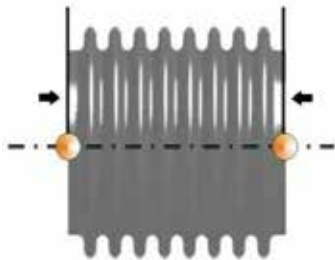

Axial movement to extension



Lateral Movement

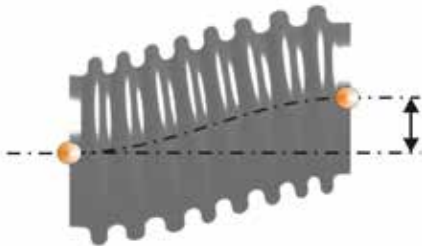

Angular Movement

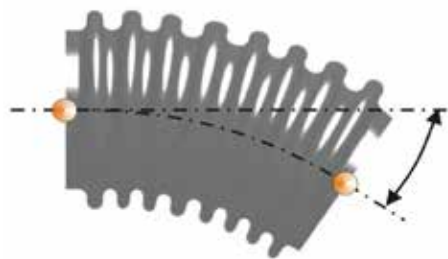

Metallic Expansion Joints

In the industrial pipe system field, different configurations of expansion joints have been developed as to cover most present situations that require attention and solution.

Metallic Expansion Joints are built as a part of a system of bellows. Their design and material depends upon the service submitted as well as the operation conditions and the fluid it will contain. Additionally to the characteristics of the design and the property of the material, the expansion joint can include a variety of accessories, as to be able to adapt to a specific situation.

For more information or questions please contact our technical support team. If you should not know any data or characteristic required we will gladly help you.



Metallic Expansion Joint: Simple

The extremes of the bellow can be welded or flanged. This is ideal to absorb axial movements and vibrations, as well as small lateral and angular movements, by itself or combined, as long as there are at one level to avoid torsion.



Description

It is the most used model, easy and economical.

Perfect to absorb axial movements in pipe systems.

It should not be submitted to torsion.

It requires a controlled, anchored and guided pipe system to guaranty perfect functioning.

Axial movement to Compression and Extension

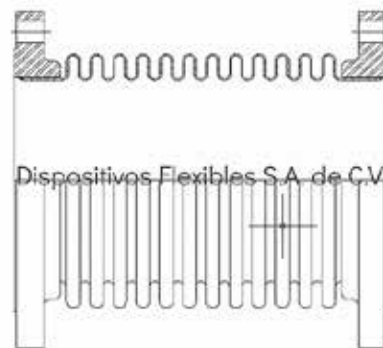
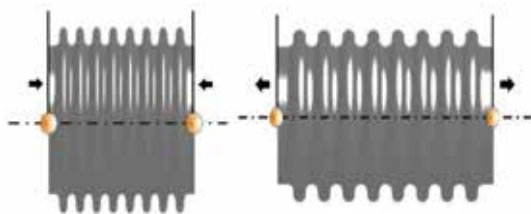

Metallic Expansion Joint: Duplex

Made of two bellows joint by a central tube spool anchored at the center.

This joint is designed to absorb axial and angular movement using the anchoring to divide de pipe system into two independent parts, so each bellow acts like a simple joint for each part of the system. Achieving the combination of the different movements present in the pipe system.

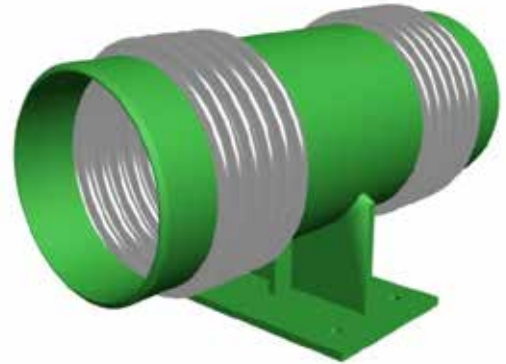

Description

Perfect to absorb angular and axial movement, as well as small lateral movements.

It can absorb the combination of two different movements present in the pipe system.

Because of the way of operation of this joint, it is necessary to use central anchoring.

Axial movement to Compression and Extension

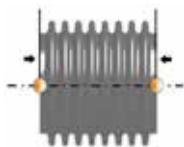

Angular Movement

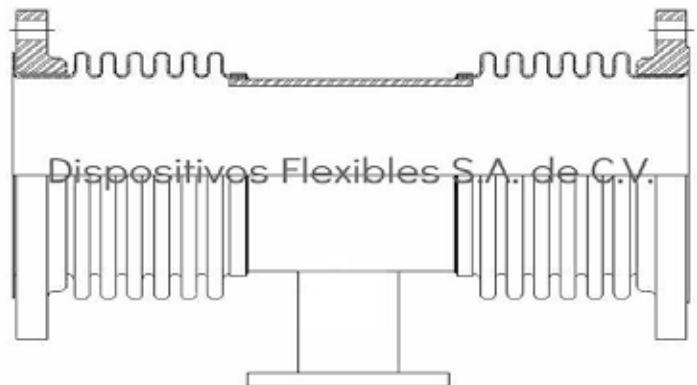

Metallic Expansion Joint: Universal

Formed by two simple bellows linked by a central spool and control bars that limit movements and support the possible pressure that lacking anchors in the pipe system could cause. It has the capacity to absorb big lateral movement, which can be increased by extending the central spool.



Lateral Movement

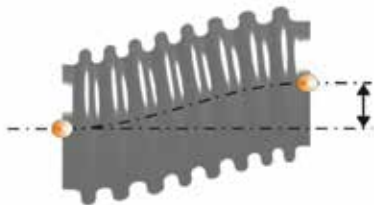

Description

Perfect to absorb angular and axial movement, as well as small lateral movements.

It can absorb the combination of two different movements present in the pipe system.

The capacity of absorption depends on the bellow design and the length of the central spool.

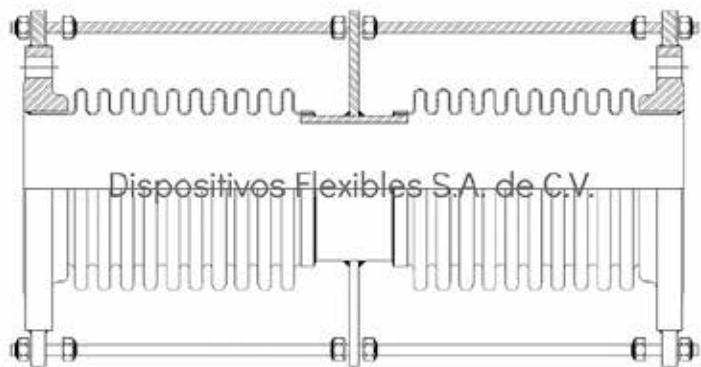

Lateral movement Universal Joint



Universal joint short spool.

Universal joint long spool.

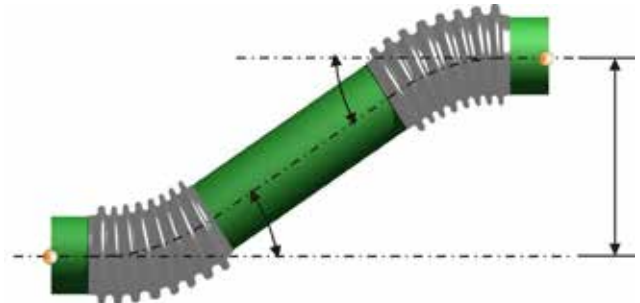
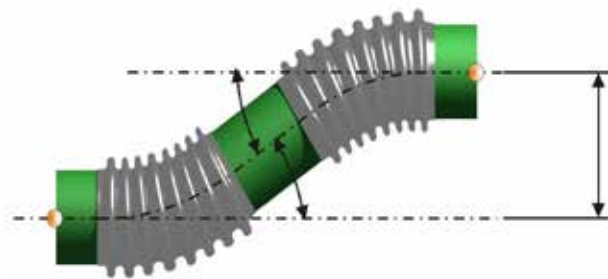

Increases the capacity to absorb lateral movement of a universal joint, increasing at the same time the length of the central spool.

Metallic Expansion Joint: Pressure Balanced

This type of expansion joint consists in one or two bellows in the flux section and one balance bellow in the posterior part of the elbow.

As its name indicates its function is to balance or reduce the reaction strength caused by internal pressure.



Description

Perfect to absorb axial and lateral movement.

It restricts the push strength in the pipes.

It requires a minimum of guidance and eliminates the use of principal anchoring.

Axial movement to Compression and Extension

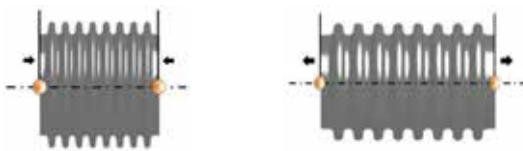

Lateral Movement

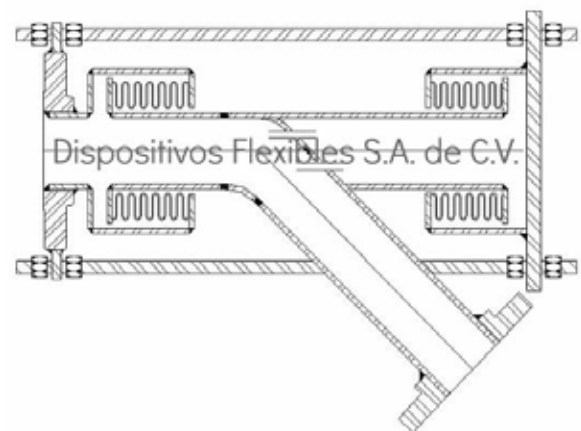

Metallic Expansion Joint: With hinge

This joint counts with just one bellow and has accessories that force it to only work in angular way and on one level at the same time that it supports internal pressure.

It can be used to absorb big expansion when placed correctly in the pipe system.



Description

The design with hinge allows total control in the bellow movement preventing torsions and maximizing its span of life.

Ideal angular movement absorption in one level.

For major lateral movement a double joint with two bellows joint by a central spool can be applied.

Angular Movement

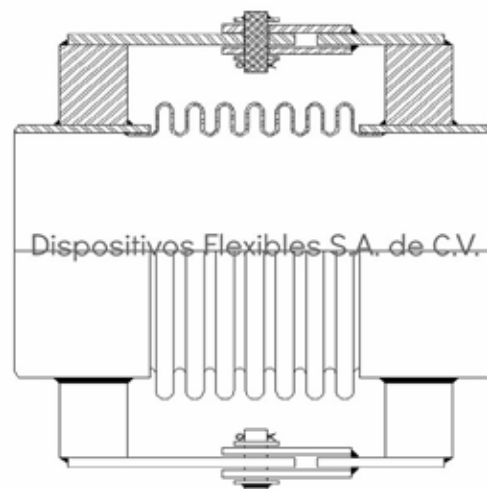

Metallic Expansion Joint: Cardan

This type of expansion joint has only one bellow and counts with movement limiting accessories, which only permits angular movements in two dimensional levels. It is used in combination with two or more similar joints and it does not produces expansion strength caused by internal pressure.

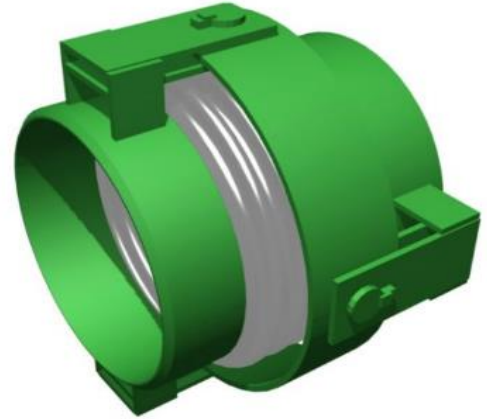

Description

It maintains total control of the bellow preventing torsions and maximizing its span of life.

Its design allows absorption of angular movements in two levels.

For major lateral movements a double joint with two bellows joint by a central spool can be applied.

Angular Movement

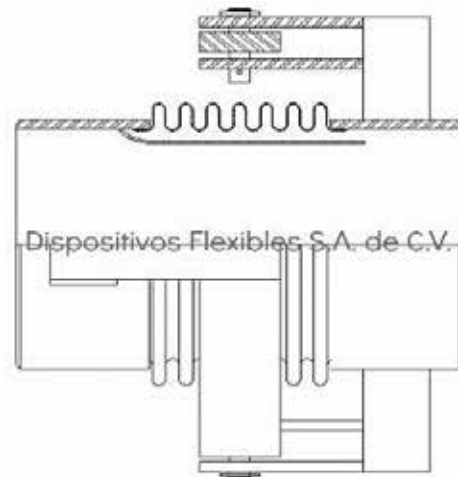

Metallic Expansion Joint: Tipo "X" Alta Presión

The construction of this type of joints forces the bellow to work under external pressure, which allows major length of the corrugated parted and therefore has major absorption of axial movement on one side and supports major pressure than the joints with bellow submitted to internal pressure.

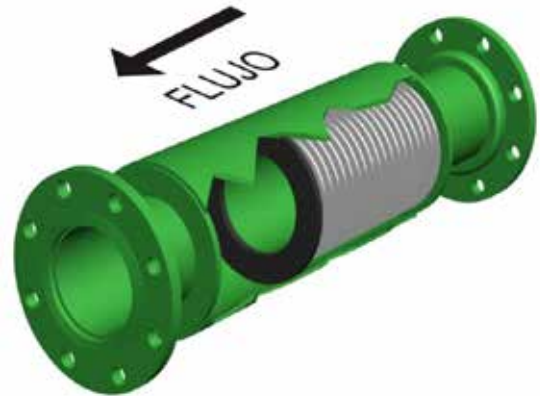

**Axial movement
to compression**

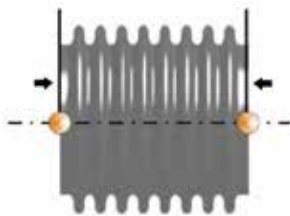

Description

Major absorption of compression axial movement and resistance to high pressure.

This type of joint is ideal for absorption of very big axial movements.

For major axial movements a double joint can be installed.

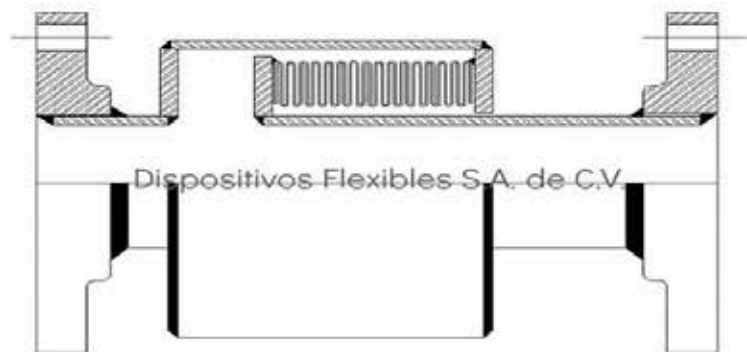

Rectangular Expansion Joints

Metallic Rectangular Expansion Joints have a variety of uses in energy generation, refinement, petrochemical, chemical and steel industry.

As there are no standard sizes of ducts and as there is a great variety of combinations in pressure and temperature, every metallic rectangular expansion joint is specifically designed to provide the most economical option, without sacrificing the integrity of the expansion joint or the system.

Metallic Rectangular Expansion Joints can absorb axial, lateral and angular movements. At the same time the joints can be built with different types of corners that result in different grades of economy and efficiency.

Simple Rectangular Expansion Joint with 90° corners



Rectangular Expansion Joint with camera corner

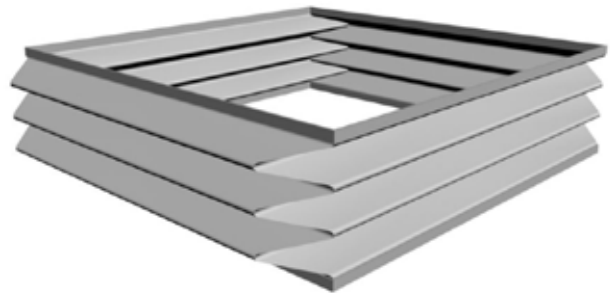

Accessories for Metallic Expansion Joints

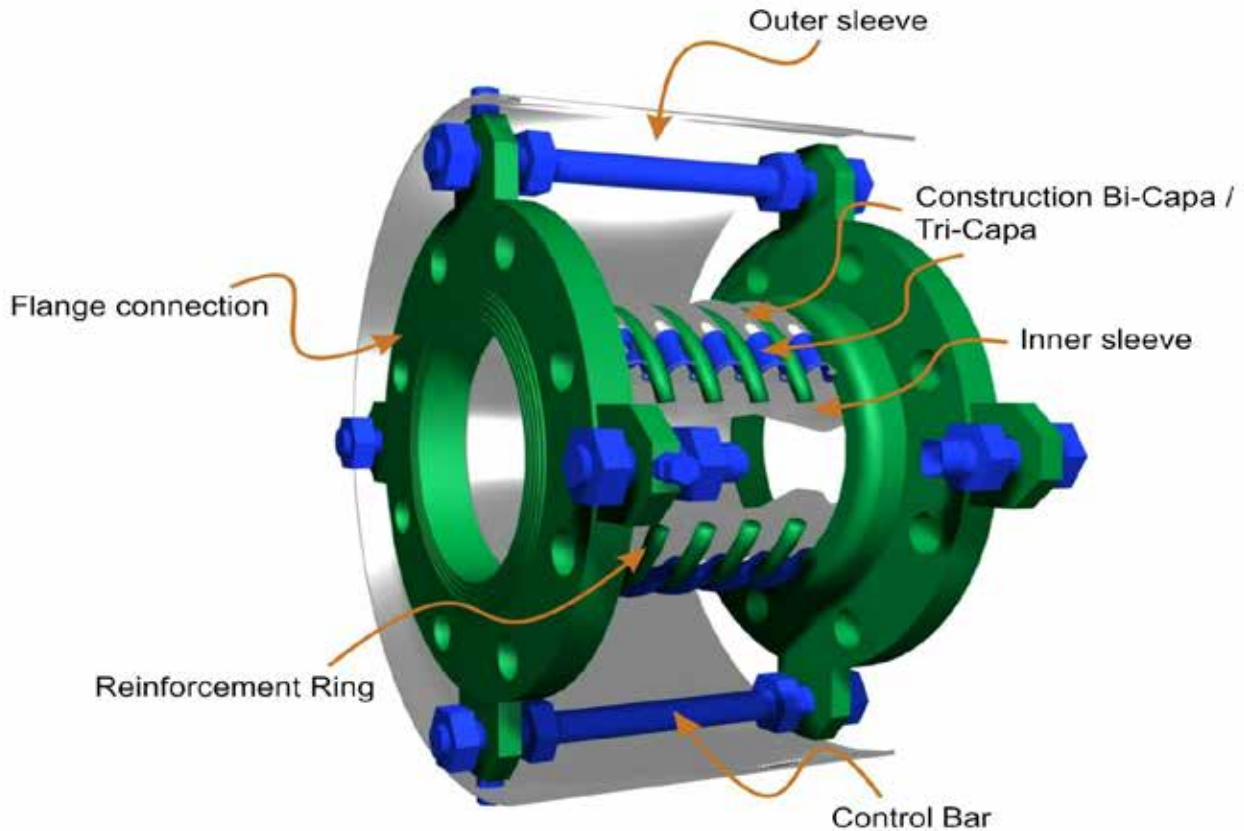

Outer Sleeve.

Shell that protects the bellow from any damage from accidental blow or bump from the work area.

Inner Sleeve.

Generally uses the same material as the bellow, it protects the bellow from damages that the fluids could cause, such as vibration, resonance, loss of resistance to fluid in the system and abrasion.

Control Bar.

The functions of this element is to control the movements of the expansion joint bellow.

Construction Bi-Capa / Tri-Capa.

Allows major flexibility and resistance to the internal pressure.

Reinforcement Ring.

Increases the capacity to support major pressure.

Positioning of pipe guides

To allow correct functioning of the pipe system with Expansion Joints it is necessary to install the right anchors and guides. Below drawing shows a pipe system with linear piping with a simple Expansion Joint and the necessary guides.

The first guide (G1) needs to be within 4 pipe diameters of the bellow, the second (G2) within 14 pipe diameters of the first guide.

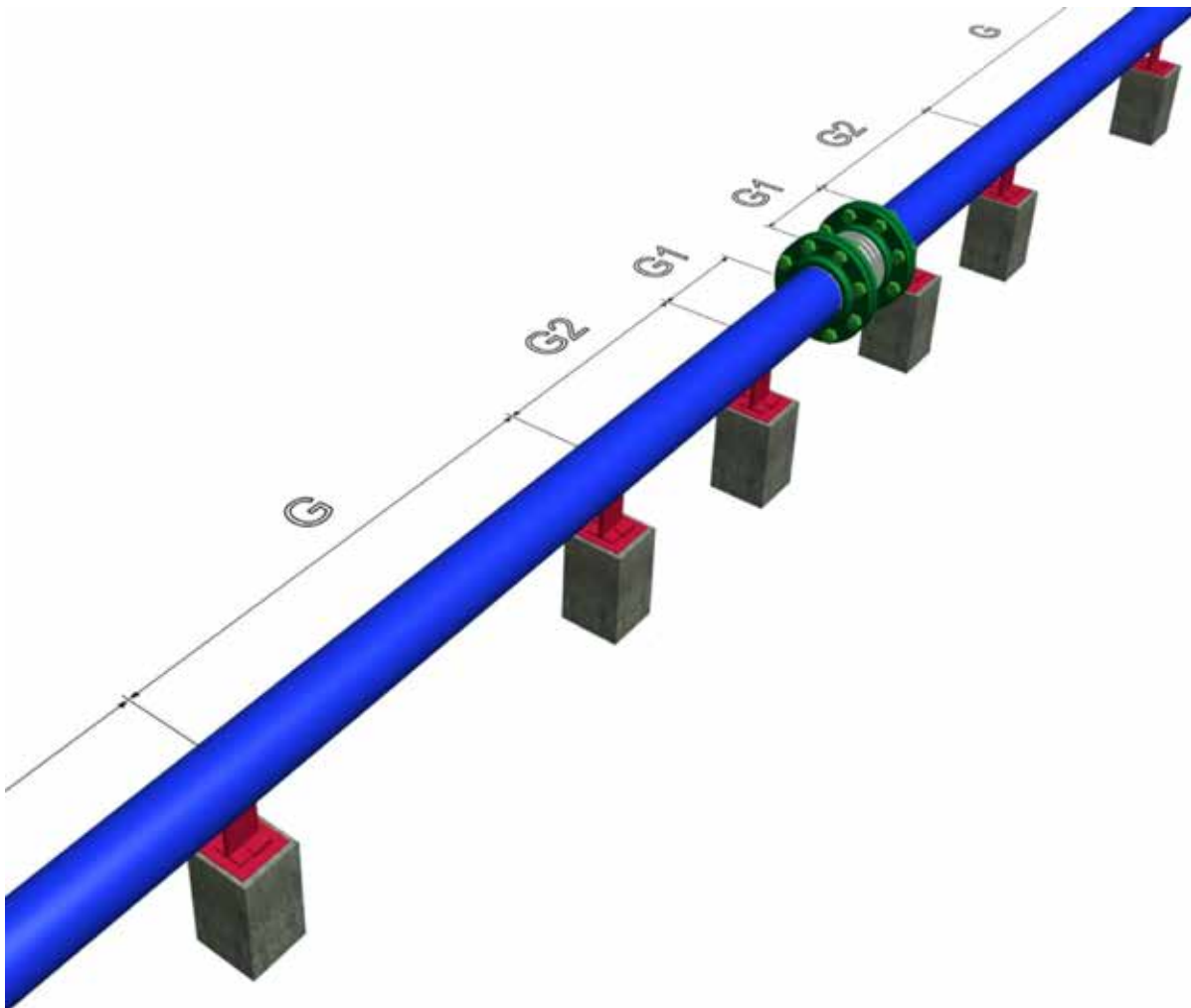

Thermal Expansion of the pipe in inches by 100 feet

Temp. Degrees F.	Carbon C-Mo. 3Cr-Mo Steels	5CR-Mo through 9Cr-Mo Steels	Austenitic Stainless Steels 18Cr-8Ni	310 SS 25 Cr-20Ni	Alloy 400	Cu-30 Ni	Copper	Nickel 200	Alloy 800,825	Alloy 600, 625,691	Aluminum	Temp. Degrees V.
-325	-2.37	-2.22	-3.85	...	-2.62	-3.15	-468	-325
-300	-2.24	-2.10	-3.63	...	-2.50	-2.87	...	-2.44	-446	-300
-275	-2.11	-1.98	-3.41	...	-2.38	-2.70	...	-2.35	-4.21	-275
-250	-1.98	-1.86	-3.19	...	-2.26	-2.53	...	-2.25	...	-2.30	-397	-250
-225	-1.85	-1.74	-2.96	...	-2.14	-2.36	...	-2.13	...	-2.17	-3.71	-225
-200	-1.71	-1.62	-2.73	...	-2.02	-2.19	...	-2.01	...	-2.04	-3.44	-200
-175	-1.58	-1.50	-2.50	...	-1.90	-2.12	...	-1.83	...	-1.87	-3.16	-175
-150	-1.45	-1.37	-2.27	...	-1.79	-1.95	...	-1.65	...	-1.70	-2.88	-150
-125	-1.30	-1.23	-2.01	...	-1.59	-1.74	...	-1.47	...	-1.54	-2.57	-125
-100	-1.15	-1.08	-1.75	...	-1.38	-1.53	-1.83	-1.29	...	-1.37	-2.27	-100
-75	-1.00	-0.94	-1.50	...	-1.18	-1.33	-1.57	-1.11	...	-1.17	-1.97	-75
-50	-0.84	-0.79	-1.24	...	-0.98	-1.13	-1.31	-0.93	...	-0.97	-1.67	-50
-25	-0.68	-0.63	-0.98	...	-0.77	-0.89	-1.05	-0.75	...	-0.76	-1.32	-25
0	-0.49	-0.46	-0.72	...	-0.57	-0.66	-0.79	-0.56	...	-0.56	-0.97	0
25	0.32	-0.30	-0.46	...	-0.37	-0.42	-0.51	-0.36	...	-0.36	-0.63	25
50	-0.14	-0.13	-0.21	...	-0.20	-0.19	-0.22	-0.16	...	-0.16	-0.28	50
70	0.00	0.00	0.00	0.00	0.00	0.00	0.00	0.00	0.00	0.00	0.00	70
100	0.23	0.22	0.34	0.32	0.28	0.31	0.34	0.25	0.28	0.26	0.46	100
125	0.42	0.40	0.62	0.58	0.52	0.56	0.62	0.47	0.52	0.48	0.85	125
150	0.61	0.58	0.90	0.84	0.75	0.82	0.90	0.69	0.76	0.70	1.23	150
175	0.80	0.76	1.18	1.10	0.99	1.07	1.18	0.92	0.99	0.92	1.62	175
200	0.99	0.94	1.46	1.37	1.22	1.33	1.48	1.15	1.23	1.15	2.00	200
225	1.21	1.13	1.75	1.64	1.46	1.59	1.77	1.38	1.49	1.38	2.41	225
250	1.40	1.33	2.03	1.91	1.71	1.86	2.05	1.61	1.76	1.61	2.83	250
275	1.61	1.52	2.32	2.18	1.96	2.13	2.34	1.85	2.03	1.85	3.24	275
300	1.82	1.71	2.61	2.45	2.21	2.40	2.62	2.08	2.30	2.09	3.67	300
325	2.04	1.90	2.90	2.72	2.44	2.68	2.91	2.32	2.59	2.32	4.09	325
350	2.26	2.10	3.20	2.99	2.68	2.96	3.19	2.56	2.88	2.56	4.52	350
375	2.48	2.30	3.50	3.26	2.91	3.24	3.48	2.80	3.18	2.80	4.95	375
400	2.70	2.50	3.80	3.53	3.25	3.52	3.88	3.05	3.48	3.05	5.39	400
425	2.93	2.72	4.10	3.80	3.52	...	4.17	3.30	3.76	3.29	5.83	425
450	3.16	2.93	4.41	4.07	3.79	...	4.47	3.55	4.04	3.53	6.28	450
475	3.39	3.14	4.71	4.34	4.06	...	4.76	3.80	4.31	3.78	6.72	475
500	3.62	3.35	5.01	4.61	4.33	...	5.06	4.05	4.59	4.02	7.17	500
525	3.86	3.58	5.31	4.88	4.61	...	5.35	4.31	4.87	4.27	7.63	525
550	4.11	3.80	5.62	5.15	4.90	...	5.64	4.56	5.16	4.52	8.10	550
575	4.35	4.02	5.93	5.42	5.18	4.83	5.44	4.77	8.56	575
600	4.60	4.24	6.24	5.69	5.46	5.09	5.72	5.02	9.03	600
625	4.86	4.47	6.55	5.96	5.75	5.35	6.01	5.27	...	625
650	5.11	4.69	6.87	6.23	6.05	5.62	6.30	5.53	...	650



DISPOFLEX

Dispositivos Flexibles S.A. de C.V.

Elastomeric Expansion Joints

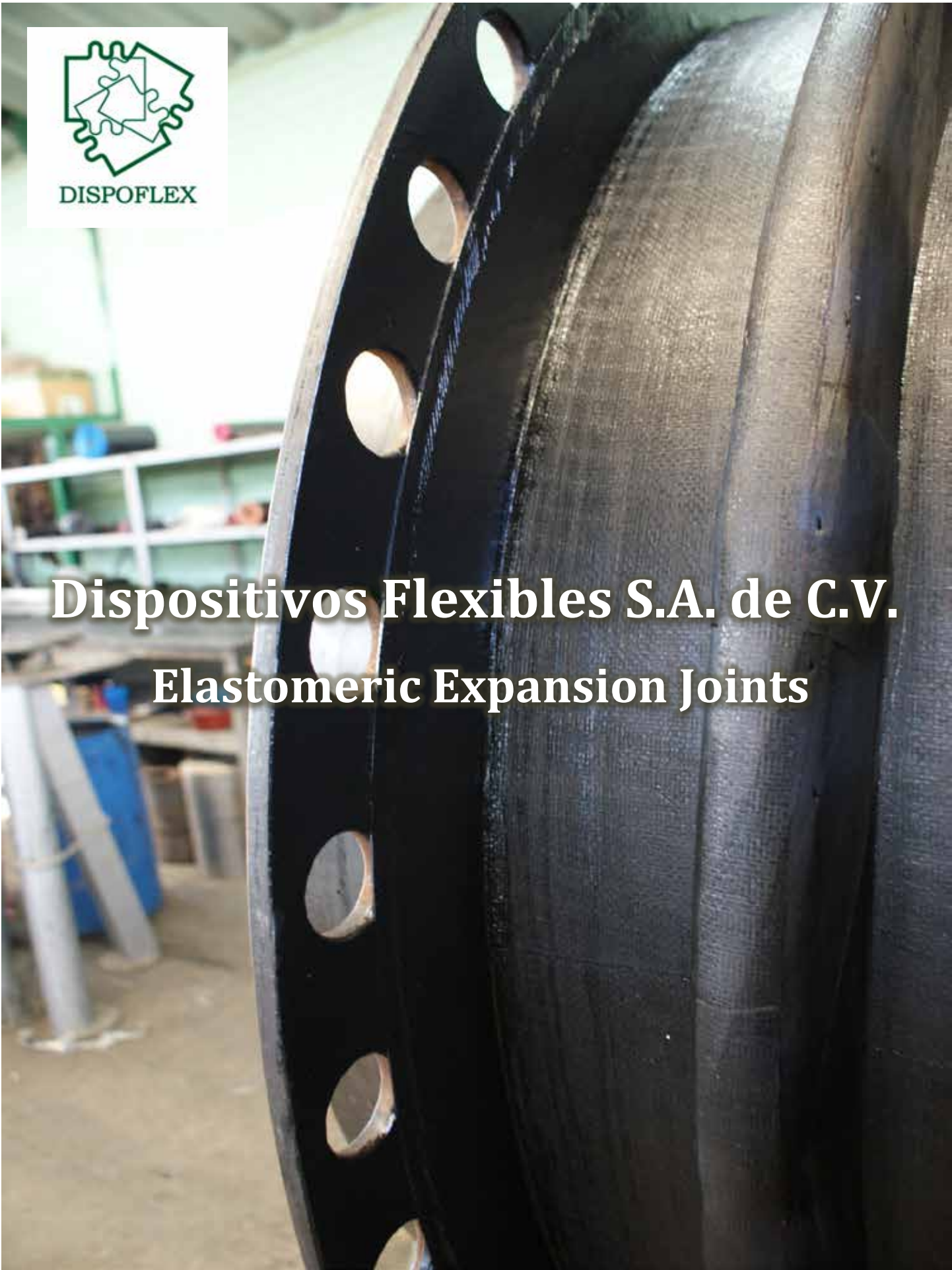



Dispositivos Flexibles S.A. de C.V.

Product Catalog

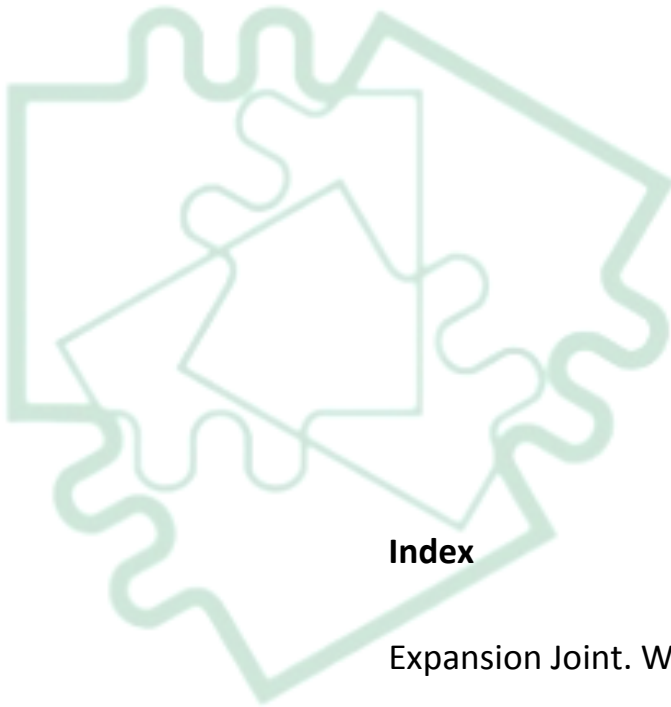

Index

Expansion Joint. What is an expansion joint?

Types of Movement.

Elastomeric Expansion Joints.

Manufacturing.

Types of Elastomeric Expansion Joints.

Accessories for Elastomeric Expansion Joints.

Anchoring and guiding of the pipe system.

Other types of installations.

Dimensional table.

Movement capacity/ strength/ constant spring.

Comparison of the chemical composition and physical properties of different elastomers.

Expansion Joint

What is an expansion joint?

When designing, producing and maintaining industrial pipe systems, different situations have to be taken into account. Such situations can be mechanical movements, vibrations, misalignments in pipes or movement caused by thermal expansion. All of these movements in the pipe are transmitted to the mounting and equipment connected to them, provoking deformations, failure and ruptures in the systems, which can lead to pricy production stops.

There are different ways to attack this situation, being the correct use of Expansion Joints in the pipes one of the most effective ones.



Expansion Joints are flexible devices designed to absorb movements generated by the pipe system because of variations in temperature and pressures. By absorbing those movements, the joints reduce the mechanical vibration caused by other equipment and diminishes the noise of the pipes.

The essential part of an Expansion Joint, which allows the movement and flexibility, is the bellow. The bellow requires to be very resistant to support the pressure of the fluids handled, but also flexible enough to absorb the present movements such as axial, lateral, angular, rotations and vibrations.



Types of Movement

Basic movements that can exist in an Expansion Joint are:

Axial movement that can be of *compression* or *extension*, **lateral** movement and **angular** movement.

One can also find **rotational** and **vibratory** movement.

Neutral Bellow

Under any pressure or temperature.

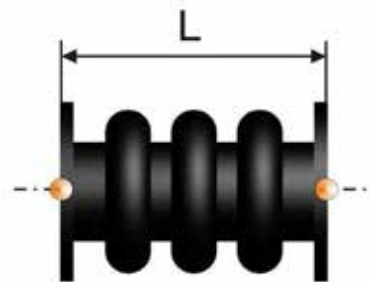

Axial movement to compression

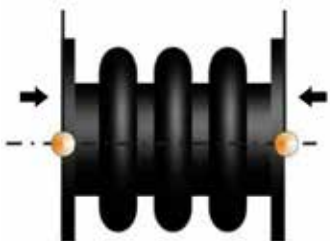

Axial movement to extension



Lateral Movement



Angular Movement



Elastomeric Expansion Joints

An expansion joint of this type is a flexible connector, produced with natural or synthetic elastomer, reinforced with polyester canvas and steel rings.

Its design and material depend on the service needed, as well as the operation condition and the containing liquid. Additionally to the characteristics of design and properties of the material, a variety of accessories can be added to adapt to the presented specific situation.

For more information or questions please contact our technical support team. If you should not know any data or characteristic required we will gladly help you.



Elastomeric Expansion Joints

Advantages

There have been technological developments in the compounds of rubber and synthetic canvas, which gives the expansion joints with these materials benefits that cannot be found with other materials.

Its compact size provides a considerable saving in Loop systems or pipe configuration, optimizing the size of the plant, installation work and loss of pressure.

The flexibility of these joints provide major absorption capacity and because of the material does not cause fatigues or cracking and prevents any electrolytic action, thanks to the rubber-metal interface of the joints with corresponding flanges.

They resist corrosion and erosion and due to the elasticity of the used material resist sudden increase in pressure or a water hammer.



Manufacturing

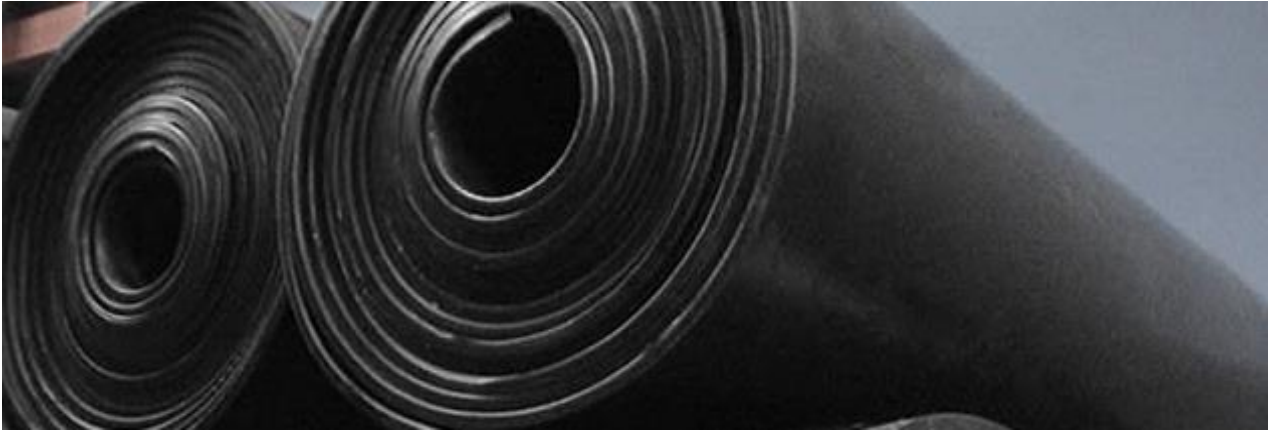

Depending on the use given to the expansion joint, as well as the operation conditions and the containing liquid, the material is different.

The elastomers used are generally: natural, Neoprene, Viton, Nitrile, Hypalon, medical rubber. These materials can be combined as one can be on the inside and the other of the outside of the joint.

As a special manner we can design and manufacture elastomeric joints with metallic liner or Teflon interior.



Types of Elastomeric Expansion Joints

One arch with integrated flanges

The construction is out of canvas and rubber, reinforced with metal or wire rings. It is designed with one simple arch or with major radio, which increases its capacity of movement and self-cleaning.

Flanges with complete face are integrated in the body of the joint. The rubber flange is thick enough to seal efficiently the partner flange without the use of gaskets.



Multiple arches with integrated flanges

This joint is similar to the one arch joint, but it has an increased capacity in absorption, depending on the number or arcs. To maintain horizontal stability it is recommended to not use more than 4 arches.

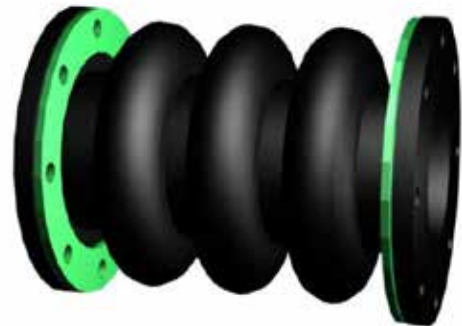

Joint with one arch and flanges of different sizes

Similar to the joint with one arch, but its flanges are of different size allowing the connection to tubes of different size according the pipe system.

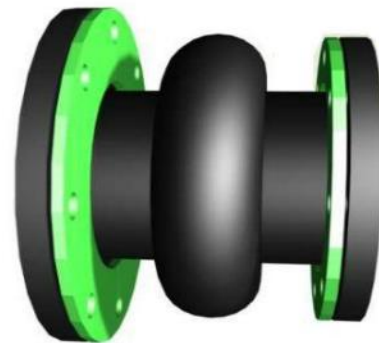

Types of Elastomeric Expansion Joints

Concentric reduction

The reduction joints are used to join pipes with different diameters without the loss of the axial shaft center. They can be manufactured with or without arch.



Eccentricity reduction

This reduction joints are used to join pipes with different diameters and the loss of the axial shaft center. They can be manufactured with or without arch.



Joint with revolving flange

Expansion joint built with revolving flanges at the extremes. The special construction counts with steel rings to reinforce the contact with the flange.



Types of Elastomeric Expansion Joints

Joints with a stuffed arch

The arch can be stuffed with soft rubber, providing a smooth pipe. It is only recommended when necessary, since the absorption capacity decreases by 50%.

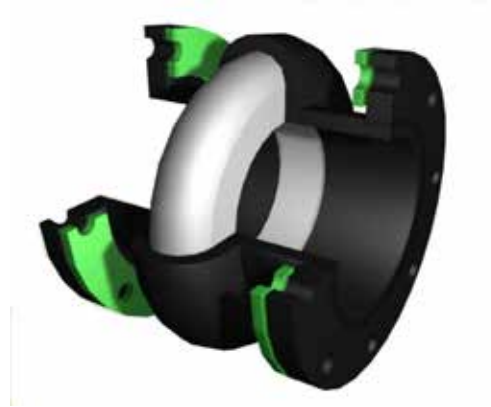

Joint with inner tube suitable to service

The inner tube can be manufactured with the most suitable material according to the containing fluid.



Inner sleeve

This accessory is a sleeve with a van stone end or complete flange face, that made of hard rubber, metal or Teflon, that extends through the interior of the extension joint. It reduces wear on the joint and smooths the flow, reducing the turbulence. It is not recommended for thick fluids.



Types of Elastomeric Expansion Joints

Joints with sleeve extrens

Sleeve ends have the same inner diameter as the pipes outer diameter, where the joint is placed and fixed with clamps. The use is only recommended with medium pressure or vacuum, since air tightness cannot be guaranteed with the clamp.



“U” type joints with or without flanges

“U” type joints are recommended for a total vacuum or a pressure of max. 25 PSIG and are normally used between turbines and condenser.

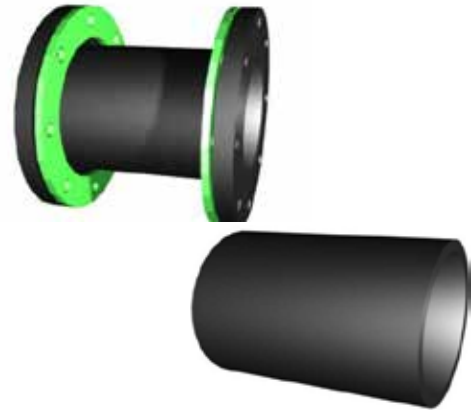

Joints with sphere type corrugation

This joint has an arch with big radius which gives it greater the movement absorption capacity over the traditional design. The design is also self-cleaning which eliminates the need for a stuffing in the arch.



Types of Elastomeric Expansion Joints

Rectangular joint

This joint fits rectangular flanges and their behaviour is similar to the circular ones.



Special Orders

Joints with gap

This specialty joint is generally used when there is a level difference in the pipes, so as to join them without a problem.



- For more information or special requirements please contact our technical support team. Our engineers will attend you swiftly.

Accessories for Elastomeric Expansion Joints

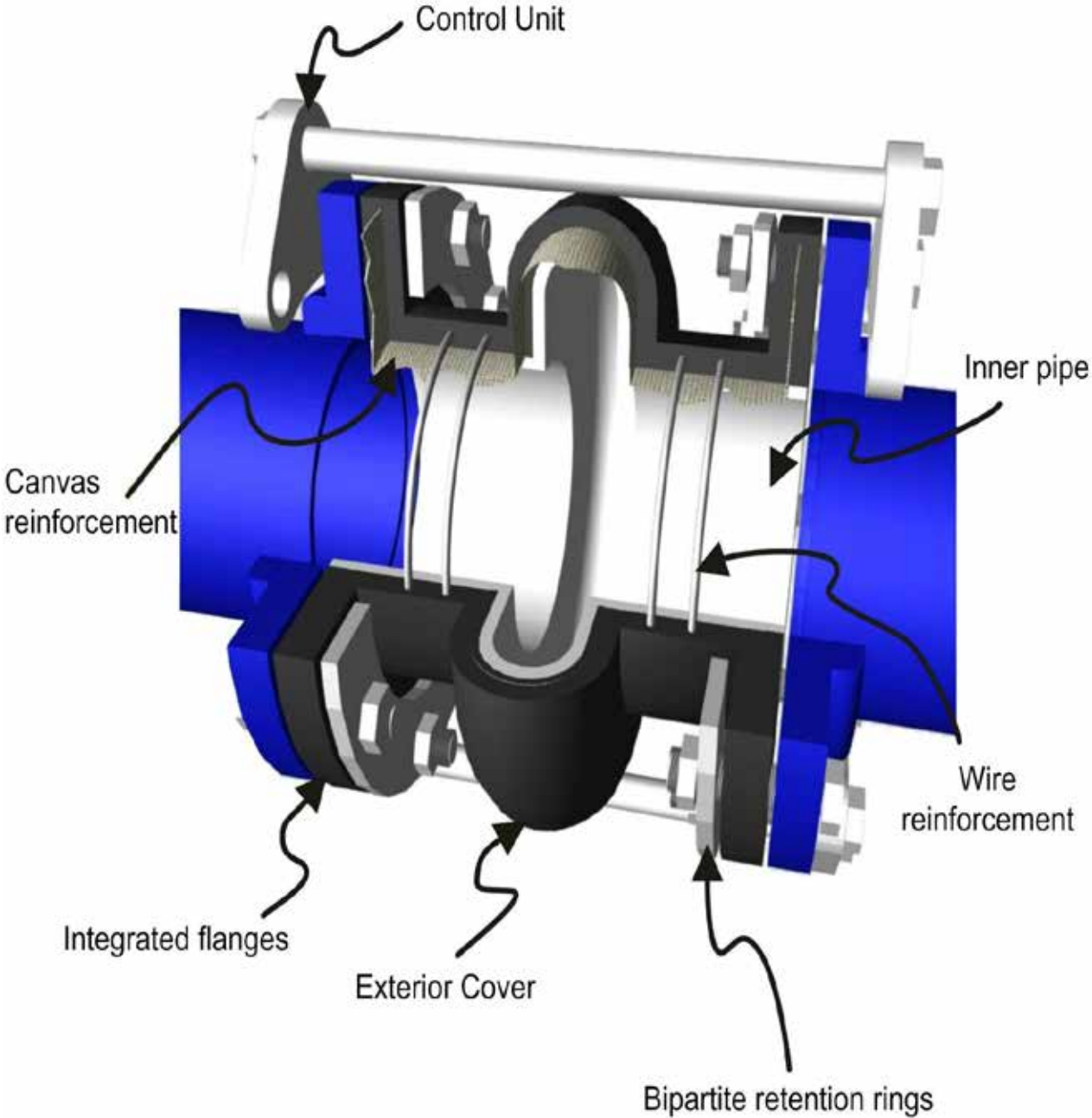

Accessories for Elastomeric Expansion Joints

Inner pipe

Internal surface that is in direct contact with the liquid. It is made of the appropriate elastomer for the operation conditions and the containing liquid of the joint.

Body

It is build out of rubber layers and reinforced by nylon canvas to support the pressure.

Integrated flanges

The flanges are made of the body of the joint and the same material. Built under norms ANSI 150# and 300#.

Control Unit

Limits the movements of the expansion joint to the permitted value.

Exterior cover

Can be made of the same elastomer as the inner pipe or a different one, depending on the environmental conditions the pipe will be subdued.

Wire reinforcement

It reinforces the body of the joint to support the pressure and avoid deformations.

Bipartite retention rings

Their function is to reinforce the sealing between the integrated flanges of the joint and the flanges where it will be installed.



Anchoring and guiding of the pipe system

Typical pipe arrangement with correct use of expansion joints, guides and anchoring.

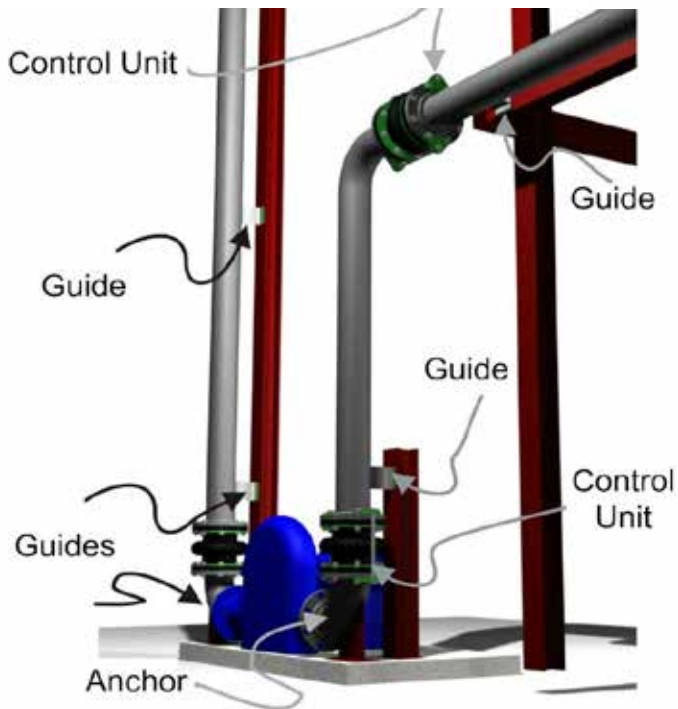
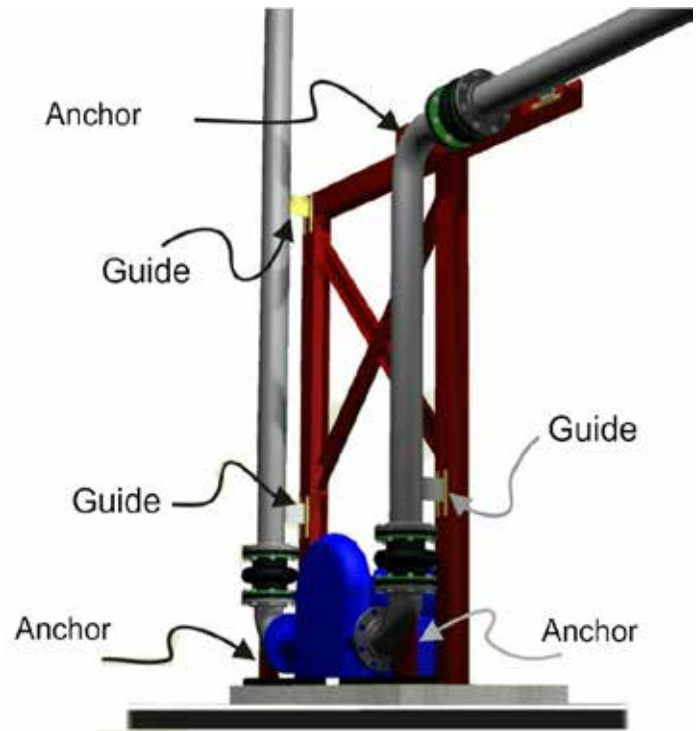

Typical arrangement using expansion joints and control units, where is not possible anchoring.

Other types of installations

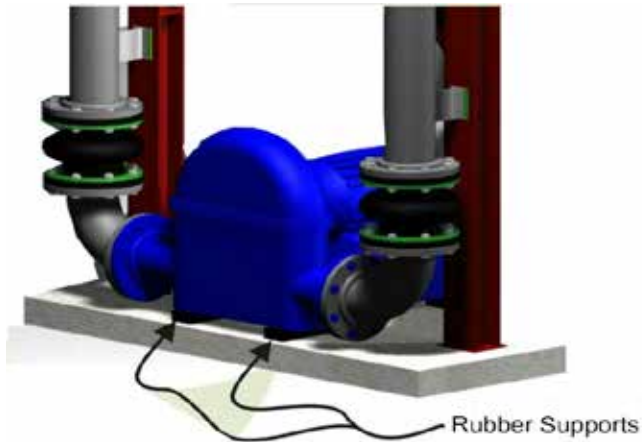

System with only one pump installed on a rubber support that can bear the systems weight and the push of pressure. The pump Shell, nozzles and elbows need to support the same strength.

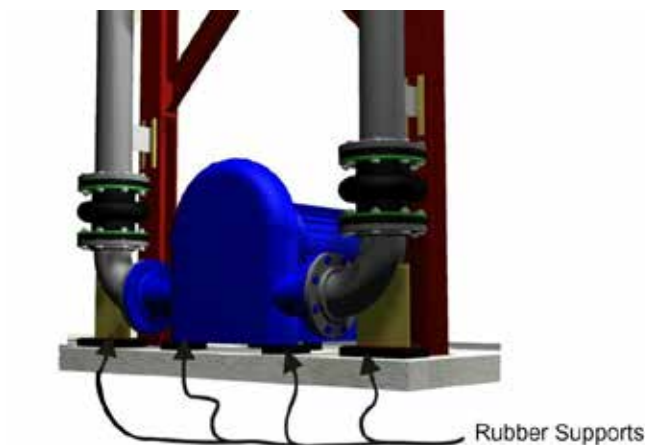

System with the pump and elbow on a rubber support. The pump shell doesn't need to support the force on the nozzles and elbow because of the system weight, as well as the push of pressure on joints since the elbows have their own support.

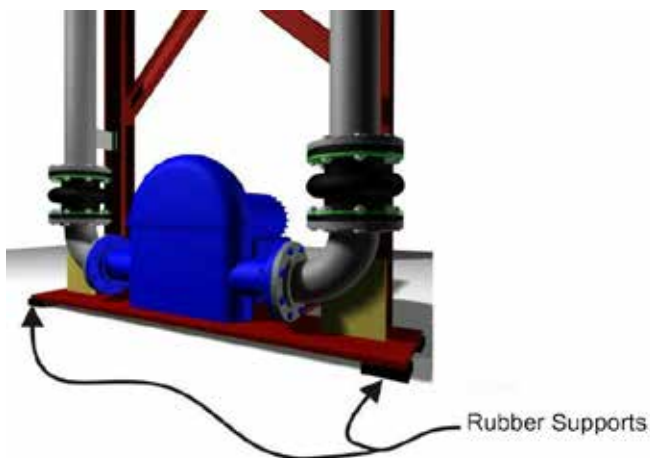

Alternative system with a second level supported on rubber, in this case the pump doesn't need to support the force on the nozzles and elbow because of the system weight, as well as the push of pressure on joints neither, since the elbows have their own support.

Dimensional table

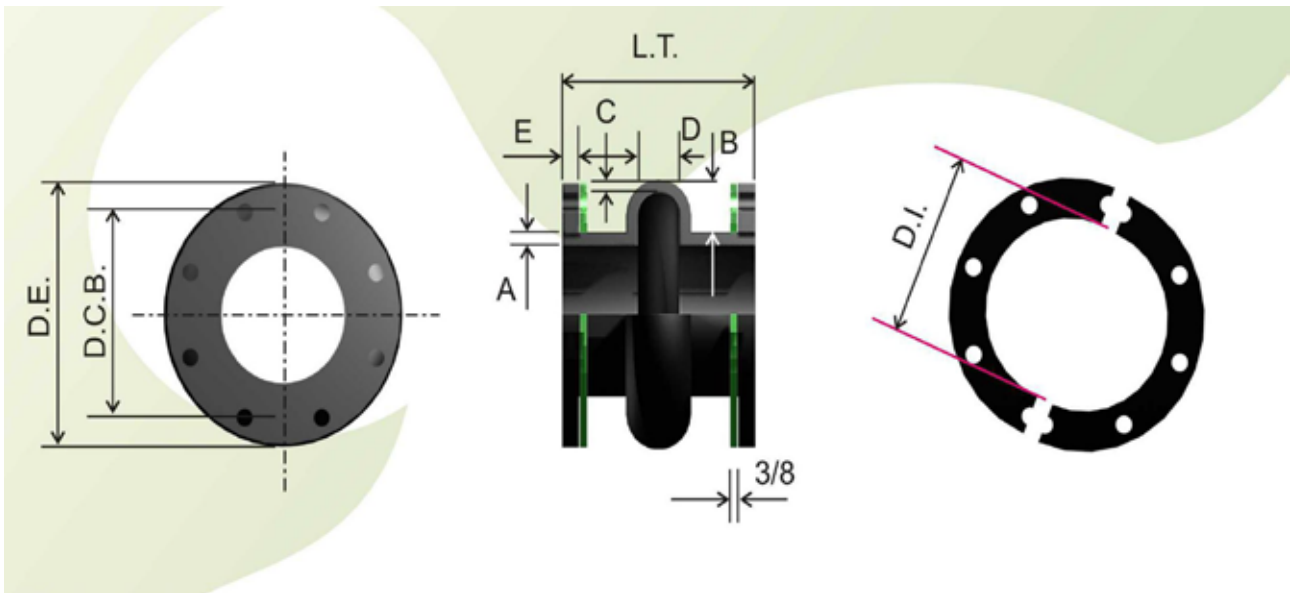

DIAM. NOM.	BRIDA DIAM. EXT.	DIAM. C.B.	BARRENOS		A. RET. DIAM. INT.	A	B	C	D	E	LON. TOT			MOV. ARCO		PRES. TRABAJO P	PESO (lbs)	
			NÚMERO	DIÁMETRO							1 ARCO	2 ARCO	3 ARCO	AXIAL COMP	AXIAL EXT.		J.E.	ANILLO
2	6	4 3/4	4	3/4	3 5/8	3/4	1 1/4	1/2	1/2	9/16	6	10	12	7/16	1/4	165	4	4
2 1/2	7	5 1/2	4	3/4	4 1/8	3/4	1 1/4	1/2	1/2	9/16	6	10	12	7/16	1/4	165	4.5	5.5
3	7 1/2	6	4	3/4	4 5/8	3/4	1 1/4	1/2	1/2	9/16	6	10	12	7/16	1/4	165	5.25	6
4	9	7 1/2	8	3/4	5 7/8	7/8	1 1/4	1/2	1/2	9/16	6	10	12	7/16	1/4	165	8	7.38
5	10	8 1/2	8	7/8	6 7/8	7/8	1 1/4	1/2	1/2	9/16	6	10	12	7/16	1/4	140	8.25	8.75
6	11	9 1/2	8	7/8	7 7/8	7/8	1 1/4	1/2	1/2	5/8	6	10	12	7/16	1/4	140	9.75	10
8	13 1/2	11 3/4	8	7/8	9 7/8	7/8	1 1/2	5/8	3/4	3/4	6	10	14	11/16	3/8	140	15	14
10	16	14 1/4	12	1	12 1/8	1	1 1/2	11/16	3/4	3/4	8	12	14	11/16	3/8	140	23	18
12	19	17	12	1	14 1/2	1 3/16	1 1/2	11/16	3/4	3/4	8	12	14	11/16	3/8	140	40	25
14	21	18 3/4	12	1 1/8	16 1/2	1 3/16	2	3/4	3/4	7/8	8	12	16	11/16	3/8	85	39	28
16	23 1/2	21 1/4	16	1 1/8	18 1/2	1 3/16	2	3/4	3/4	7/8	8	12	16	11/16	3/8	65	45.5	35
18	25	22 3/4	16	1 1/4	20 1/2	1 3/16	2	3/4	3/4	7/8	8	12	16	11/16	3/8	65	50.5	30
20	27 1/2	25	20	1 1/4	22 5/8	1 1/4	2	25/32	7/8	1	8	12	16	13/16	7/16	65	61	41
24	32	29 1/2	20	1 3/8	26 5/8	1 1/4	2	25/32	7/8	1	10	14	18	13/16	7/16	65	75	53
26	34 1/4	31 3/4	24	1 3/8	28 7/8	1 3/8	2 1/4	13/16	1	1	10	14	18	15/16	1/2	55	85.5	57
30	38 3/4	36	28	1 3/8	32 7/8	1 3/8	2 1/4	13/16	1	1	10	14	18	15/16	1/2	55	134	66
36	46	42 3/4	32	1 5/8	39	1 3/8	2 1/4	13/16	1	1	10	14	18	15/16	1/2	55	137.5	99
40	50 1/4	47 1/4	36	1 3/4	43	1 3/8	2 1/4	13/16	1	1	10	14	18	15/16	1/2	55	160	121.25
42	53	49 1/2	36	1 5/8	45 1/4	1 1/2	2 1/2	29/32	1 1/8	1 3/16	12	14	18	1 1/16	9/16	55	256	127
44	55 1/4	51 3/4	40	1 3/4	47 1/4	1 1/2	2 1/2	29/32	1 1/8	1 3/16	12	14	18	1 1/16	9/16	55	198	136.75
48	59 1/2	56	44	1 5/8	51 1/4	1 1/2	2 1/2	29/32	1 1/8	1 3/16	12	14	18	1 1/16	9/16	55	275	154.5
50	61 3/4	58 1/4	44	1 7/8	53 1/4	1 1/2	2 1/2	29/32	1 1/8	1 3/16	12	14	18	1 1/16	9/16	55	240	163.25
54	66 1/4	62 3/4	44	2	57 1/4	1 1/2	2 1/2	29/32	1 1/8	1 3/16	12	14	18	1 1/16	9/16	55	265.5	185
60	73	69 1/4	52	2	63 1/4	1 1/2	2 1/2	29/32	1 1/8	1 3/16	12	14	18	1 1/16	9/16	55	385	221
62	75 3/4	71 3/4	52	2	65 1/4	1 1/2	2 1/2	29/32	1 1/8	1 3/16	12	14	18	1 1/16	9/16	55	325	250
66	80	76	52	2	69 1/4	1 1/2	2 1/2	29/32	1 1/8	1 3/16	12	14	18	1 1/16	9/16	55	350	270
72	86 1/2	82 1/2	60	2	75 1/4	1 1/2	2 1/2	29/32	1 1/8	1 3/16	12	14	18	1 1/16	9/16	45	445	303

Movement capacity/ strength/ constant spring

tamaño nominal de la junta de expansión pulg.	longitud mínima recomendada cara a cara pulg.	pulgadas de compresión axial	pulgadas de extensión axial	pulgadas de deflexión lateral	grados de movimiento angular	grados de movimiento torsional	carga total para el rango de compresión en libras	carga total para el rango de extensión en libras	carga total para el rango de deflexión lat. en libras	carga total para el rango de rotación ang. en pie- libras	fuerza en lbs. para comprimir 1"	fuerza en lbs para extender 1"	fuerza en lbs para desplazar lateral 1"	fuerza en pie-lbs para rotar angularmente 1"
1/4	6	7/16	1/4	1/2	-	-	-	-	-	-	-	-	-	-
3/8	6	7/16	1/4	1/2	-	-	-	-	-	-	-	-	-	-
1/2	6	7/16	1/4	1/2	46	3	58	43	87	0.3	133	172	174	0.006
3/4	6	7/16	1/4	1/2	34	3	87	64	131	0.7	199	256	262	0.02
1	6	7/16	1/4	1/2	27.5	3	103	76	175	1	235	304	350	0.04
1-1/4	6	7/16	1/4	1/2	22.5	3	129	96	219	2	294	383	438	0.1
1-1/2	6	7/16	1/4	1/2	18.5	3	154	115	262	3	353	459	524	0.15
2	6	7/16	1/4	1/2	14.5	3	185	138	350	4	423	552	700	0.3
2-1/2	6	7/16	1/4	1/2	11.5	3	232	172	381	6	530	689	752	0.5
3	6	7/16	1/4	1/2	10	3	278	207	412	8	635	828	824	0.8
3-1/2	6	7/16	1/4	1/2	8.3	3	324	241	444	11	742	965	888	1.3
4	6	7/16	1/4	1/2	7.5	3	371	276	476	14	848	1104	952	1.9
5	6	7/16	1/4	1/2	6	3	463	344	546	22	1058	1376	1092	3.7
6	6	7/16	1/4	1/2	5.0	3	556	413	617	32	1271	1652	1234	6.4
8	6	11/16	3/8	1/2	5.5	3	971	689	753	70	1412	1837	1506	12.7
10	8	11/16	3/8	1/2	4.5	3	1214	861	809	109	1766	2296	1618	24.2
12	8	11/16	3/8	1/2	3.75	3	1456	1033	948	158	2118	2755	1896	42.1
14	8	11/16	3/8	1/2	3.25	2	1274	904	1117	160	1853	2411	2234	19.2
16	8	11/16	3/8	1/2	2.75	2	1456	1033	1286	209	2118	2755	2572	76
18	8	11/16	3/8	1/2	2.5	1	1638	1163	1420	266	2382	3101	2840	106
20	8	13/16	7/16	1/2	2.5	1	2152	1505	1588	381	2649	3440	3176	152
22	10	13/16	7/16	1/2	2.25	1	2367	1656	1648	463	2913	3785	3296	205
24	10	13/16	7/16	1/2	2	1	2582	1807	1706	549	3178	4130	3412	274
26	10	15/16	1/2	1/2	2.3	1	2869	1990	1829	659	3060	3980	3658	292
28	10	15/16	1/2	1/2	2	1	3090	2143	1952	765	3296	4286	3904	382
30	10	15/16	1/2	1/2	2	1	3311	2297	2075	875	3532	4594	4150	437
32	10	15/16	1/2	1/2	1.8	1	3531	2450	2438	1000	3769	4899	4876	555
34	10	15/16	1/2	1/2	1.75	1	3752	2603	2801	1130	4002	5602	5602	645
36	10	15/16	1/2	1/2	1.5	1	3973	2756	3164	1266	4238	5512	6328	844
38	10	15/16	1/2	1/2	1.5	1	4194	2909	3251	1415	4475	5818	6502	943
40	10	15/16	1/2	1/2	1.5	1	4414	3062	3338	1563	4708	6124	6676	1042
42	12	1-1/16	9/16	1/2	1.5	1	4732	3253	3423	1745	4452	5783	6846	1163
44	12	1-1/16	9/16	1/2	1.5	1	4958	3407	3571	1906	4664	6057	7142	1270
46	12	1-1/16	9/16	1/2	1.3	1	5181	3562	3718	2090	4870	6339	7436	1680
48	12	1-1/16	9/16	1/2	1.25	1	5408	3717	3866	2282	5087	6608	7732	1825
50	12	1-1/16	9/16	1/2	1.25	1	5634	3872	4012	2460	5300	6884	8024	1968
52	12	1-1/16	9/16	1/2	1.25	1	5856	4027	4157	2672	5512	7166	8314	2138
54	12	1-1/16	9/16	1/2	1.25	1	6085	4182	4303	2885	5724	7435	8606	2308
56	12	1-1/16	9/16	1/2	1.25	1	6310	4341	4448	3081	5935	7717	8896	2464
58	12	1-1/16	9/16	1/2	1	1	6532	4492	4592	3310	6148	7992	9184	3310
60	12	1-1/16	9/16	1/2	1	1	6761	4651	4736	3537	6360	8268	9472	3537
66	12	1-1/16	9/16	1/2	1	1	7437	5116	5108	4288	6995	9095	10216	4288
72	12	1-1/16	9/16	1/2	0.9	1	8113	5581	5477	5113	7632	9922	10954	5681
78	12	1-1/16	9/16	1/2	0.9	1	8789	6046	5951	6022	8268	10748	11902	7022
84	12	1-1/16	9/16	1/2	0.8	1	9465	6511	6425	6913	8904	11575	12850	8641
96	12	1-1/16	9/16	1/2	0.7	1	10817	7441	7375	9409	10176	13228	14750	13441
102	12	1-1/16	9/16	1/2	0.66	1	11488	7899	7850	11198	10812	14056	15700	16967
108	12	1-1/16	9/16	1/2	0.62	1	12169	8372	8325	13550	11448	14883	16552	21855
120	12	1-1/16	9/16	1/2	0.56	1	13521	9302	9275	16728	12720	16537	18550	29871
132	12	1-1/16	9/16	1/2	0.51	1	14866	10222	10144	17109	13992	18190	20288	33547
144	12	1-1/16	9/16	1/2	0.47	1	16218	11152	11013	20164	15264	19843	22026	42902



Comparison of the chemical composition and physical properties of different elastomers

CODIGO DE LA ESCALA								
7-	EXCEPCIONAL	5-	MUY BUENO	3-	DE JUSTO A BUENO	1-	DE POBRE A JUSTO	X CONTACTAR AL FABRICANTE
6-	EXCELENTE	4-	BUENO	2-	JUSTO	0-	POBRE	
NOMBRE COMUN / nombre de grupo químico								
CARACTERISTICAS	NEOPRENO	HULE NATURAL	CLOROBUTILO	BUNA-N/NITRILO	HYPALON	VITON	EPDM	TEFLON/PTFE
QUIMICAS	chloroprene	Polyisoprene, sintético	Cloroisobutene-isoprene	Nitrile-butadiene	Clorosulfonyl-poliéstereno	fluorocarbonelastomer	Etileno propylene-diene-terpolymer	Fluoro-etilenopolímeros
DESIGNACION MATERIAL								
ANSI/ASTM D1418-77	CR	IR	CIIR	NBR	Csm	FKM	Epr	AFMU
ASTM D-2000 D1418-77	A.C. SEA	Aa	Aa BA	SEA BK Ch	CE	HK	BA Ca DA	
OZONO	5	0	6	2	7	7	7	7
TIEMPO	6	2	5	2	6	7	6	7
LUZ DEL SOL	5	0	5	0	7	7	7	7
OXIDACION	5	4	6	4	6	7	6	7
CALOR	4	2	5	4	4	7	6	7
FRIO	4	5	4	3	4	2	5	X
LLAMA	4	0	0	0	4	6	0	X
RASGON	4	5	4	3	3	2	4	X
ABRASION	5	6	4	4	4	5	5	4
IMPERMIABILIDAD	4	2	6	4	4	5	4	X
DINAMICO	2	2	2	5	2	5	5	X
REBOTE - CALIENTE	5	6	5	4	4	4	6	X
REBOTE - FRIO	4	6	0	4	2	2	6	X
SISTEMA DE LA COMPRESION	2	4	3	5	2	6	4	X
FUERZA EXTENSIBLE	4	6	4	5	2	5	5	X
FUERZA DIELECTRICA	5	6	5	0	5	5	7	X
ASLAMIENTO ELECTRICO	3	5	5	1	3	3	6	X
ABSORCION DEL AGUA	4	5	5	4	4	5	6	7
RADIACION	5	6	4	5	5	5	7	3
EL HINCHARSE EN ACEITE	4	0	0	5	4	6	0	7
ACIDO, DILUIDO	6	3	6	4	6	5	6	7
ACIDO, CONCENTRADO	4	3	4	4	4	6	4	7
HIROCARBUROS ALFATICOS	3	0	0	6	3	6	0	7
HIROCARBUROS AROMATICOS	2	0	0	4	2	6	0	7
HIROCARBUROS OXIGENADOS	1	4	4	0	1	0	6	7
LACAS	0	0	3	2	3	1	3	7
GASOLINA Y ACEITE	4	0	0	5	4	6	0	7
ALCALI, DILUIDO	4	X	4	4	4	4	6	7
ALCALI, CONCENTRADO	0	X	4	0	4	0	6	7
ACEITE VEGETAL Y ANIMAL	4	X	5	5	4	6	5	7
PRODUCTO QUIMICO	3	3	6	3	6	6	6	7
AGUA	4	5	5	4	5	5	5	7

* EL TEFLON ES MARCA REGISTRADA DE DUPONT Y AQUÍ ES UTILIZADO UNICAMENTE COMO NOMBRE GENERICO PARA EL PTFE.



DISPOFLEX

Dispositivos Flexibles S.A. de C.V.

Textile Expansion Joints





DISPOFLEX

Dispositivos Flexibles S.A. de C.V.

Product Catalog

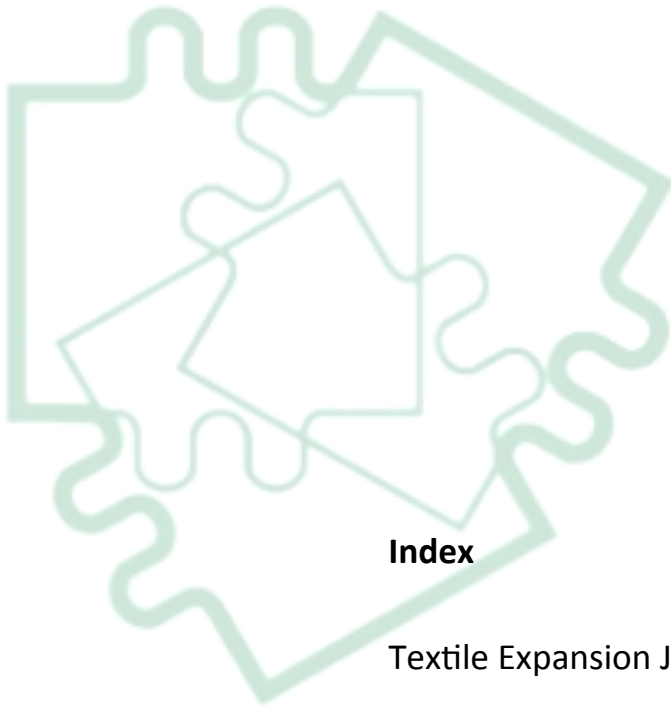

Index

Textile Expansion Joints.

Manufacturing.

Textile Expansion Joint are composed by:

Types of Textile Expansion Joints.

Types of Manufacturing.

Advantages.

Textile Expansion Joints

Non metallic or textile expansion joints are specially designed to conduct gases, chemical vapor or abrasive gases. For this reason the fabrics used are resistant to high temperatures, abrasion and corrosion, as well as wearing weather conditions.

Its design allows it to compensate axial, angular, lateral movement or torsions on their own or simultaneously, present in the pipe system.

Principally used in pipe systems with gases, hot air, dust o vapors, chimneys and energy generating plants. Its materials resist fluids up to 1200°C (2200°F) and usual pressures under 0.35 kg/cm² (5 psi).

As well as other expansion joints they are manufactured according to the needs, involved factors and required size.



Manufacturing

Depending on the use given to the expansion joint, as well as the operation conditions, temperature resistance, pressure and the containing liquid or gas, the material is different. The material used can be of different types.

Fabric:

- Glass fiber
- Polyester
- Nylon
- Cotton
- Kevlar
- Ceramic

Elastomer:

- Hypalon
- Nitrile
- Neoprene
- Polyurethane
- Silicone
- Fluorelastomer

Others:

- Plastic lamina
- Metallic lamina
- Metallic mesh
- Insulating felt
- Special accessories



Textile Expansion Joint are composed by:

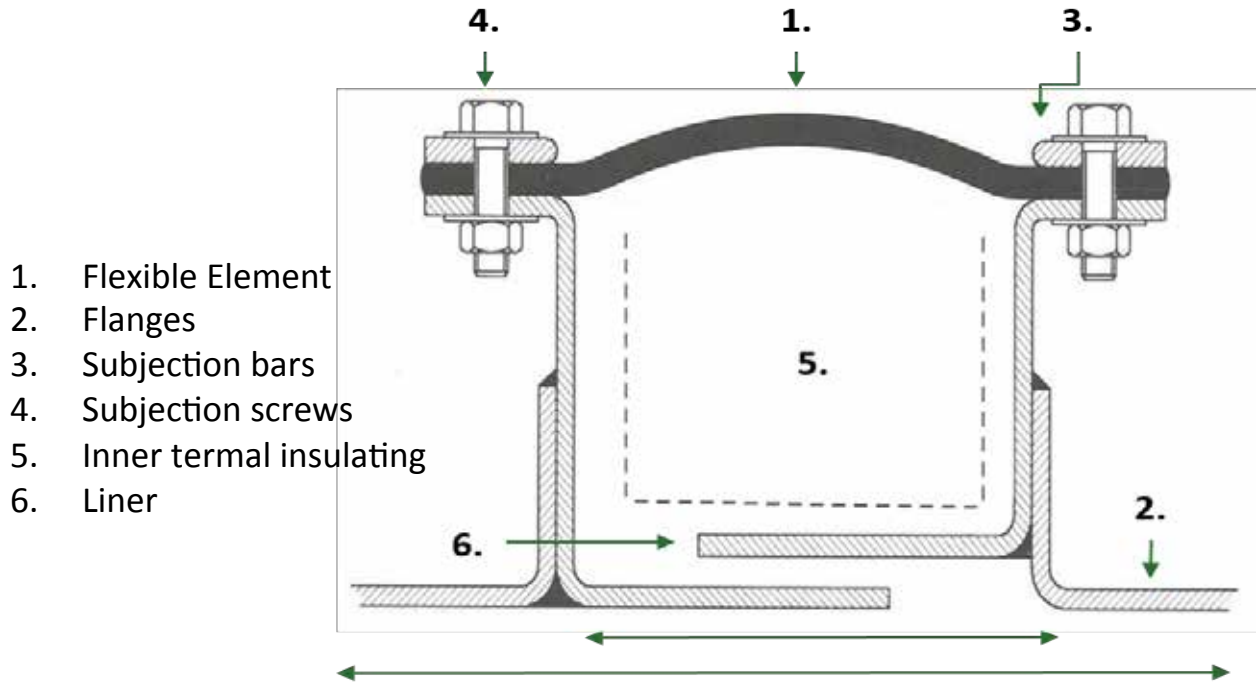

1. Flexible Element

Principal element of the expansion joint made of different materials according to the requirements of the installation. Can have one or multiple layers, offering major chemical and high temperature resistance. The outer layer reinforces the mechanical movement of the joint and may be impregnated with elastomer or out of glass fiber covered in silicone to achieve major protection to extreme weather conditions avoiding ageing.

2. Flanges

The flanges joint the expansion joint to the duct as well as providing flexibility. They can be circular, rectangular or customized.

Textile Expansion Joint are composed by:

3. Subjection bars

The subjection bars fix the flexible element to the flange. It is important, that the edges of the bars are round, to avoid cutting or tearing of the flexible element.

4. Subjection screws

Used to fix under pressure the subjection bars to the flexible element. They are of great duration and resistance and easy to install.

5. Inner thermal insulating

Stuffed with ceramic fiber of different thickness and densities, a bag of fabrics or stainless mesh, installed in the space between the flexible element and the liner and used as insulating that allows resistance to high temperatures.

6. Liner

Is the installed protection to avoid entry of particles to the inner bag and gases or smokes with dusts and other solid residues won't erode the expansion joint. At the same time it regulates temperature and pressure, avoiding turbulences, loss of charge and sudden changes of temperature in the compensator. The speed of the gases and its particle content determine what type of liner should be used.

Types of Textile Expansion Joints

Non-metallic expansion joint with extremes to Weld.

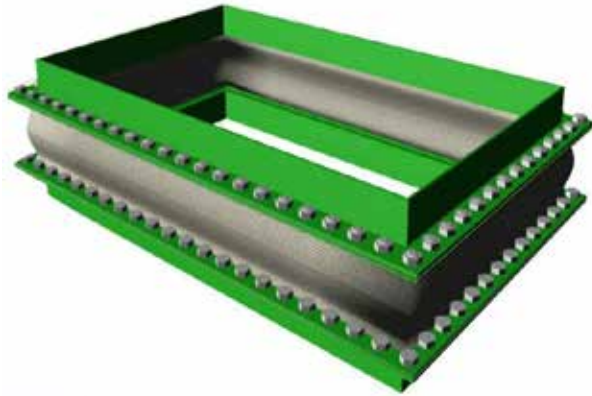

Non-metallic expansion joint with square flanges

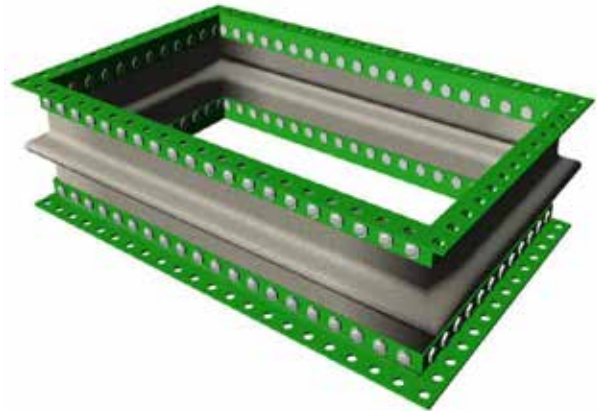

Non-metallic expansion joints with flanged extremes and inner sleeve.

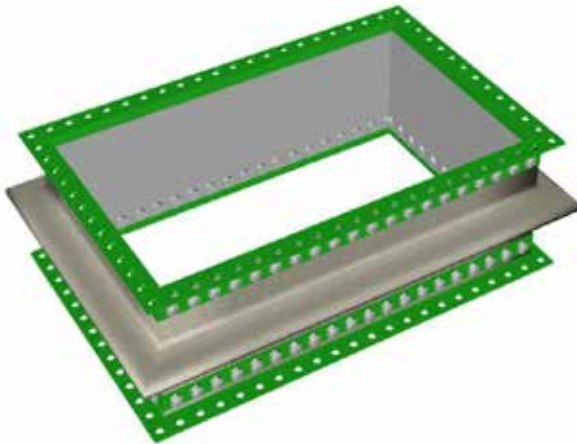

Non-metallic expansion joint with square flanges and inner sleeve.

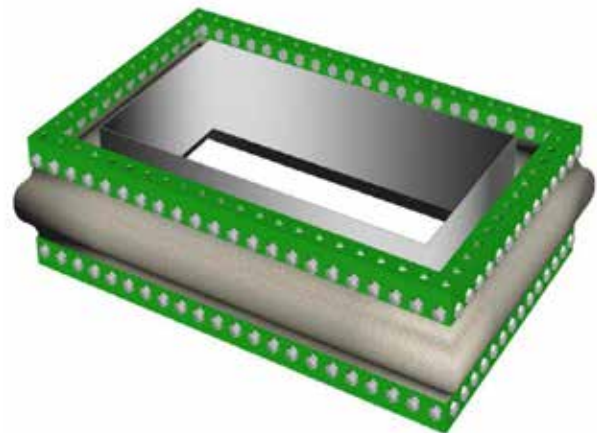

Types of Manufacturing



These flexible joints can be manufactured rectangular or circular without any limit to dimension and possibility to customize.

Advantages

- Easy installment.
- Resistance to high temperatures.
- Manages all types of gases or vapors.
- Oppression of noise and vibration.
- Low replacement cost.
- Able to absorb all four types of basic movements.
- Able to absorb different movements simultaneously.
- Able to absorb big movements on minimum length.



DISPOFLEX

Dispositivos Flexibles S.A. de C.V. Flexible Metal Hose



DISPOFLEX

Dispositivos Flexibles S.A. de C.V.

Product Catalog

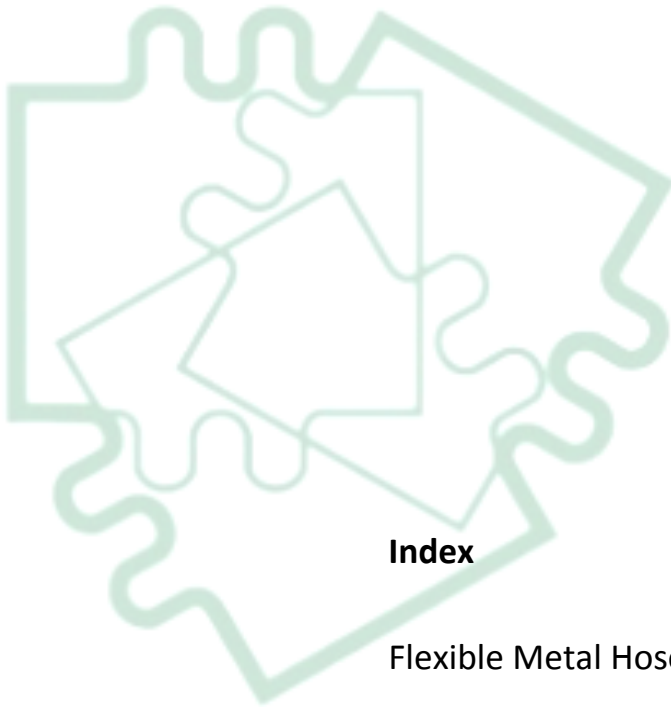

Index

Flexible Metal Hoses.

Manufacturing.

Flexible Metal Hoses are composed by:

Hose fittings types.

Installation.

Asymmetrical Expansion Joints.

Flexible Metal Hoses

They are characterized by their great resistance to pressure and temperature, opposition of vacuum and corrosion. They also possess great thermal stability as well as high flexibility and durability.

Their flexible structure allows absorbing dilatation and contraction in the pipe system as well as neutralize vibrations caused by high temperature and used pressure. They can also be used to correct un-alignments or flexible connection among mobile elements and static elements of the pipe system.



Flexible Metal Hoses are composed by:

Corrugated Stainless Steel Hose

This hose parts from a tube made of rolled sheet, welded lengthwise, that at inserting in a corrugating machine, obtains parallel and independent corrugations that provide flexibility.



Stainless Steel Braided Wire

Coating made of plaited stainless steel wire that forms a protective mesh on the exterior of the hose, joint by a coated of welding with the hose and ring. This wire braid provides major resistance avoiding that it enlarges due to internal pressure. Double braid is possible to resist higher pressures.

Flexible Metal Hoses are composed by:

Fittings

There is a wide range of fittings suitable to the specific need of the industry. The fittings are welded to the hose at its extremes and allow the joining of the hose to the equipment or pipe system.

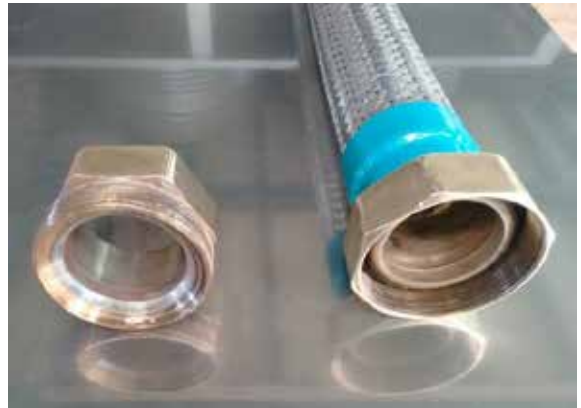

Ring





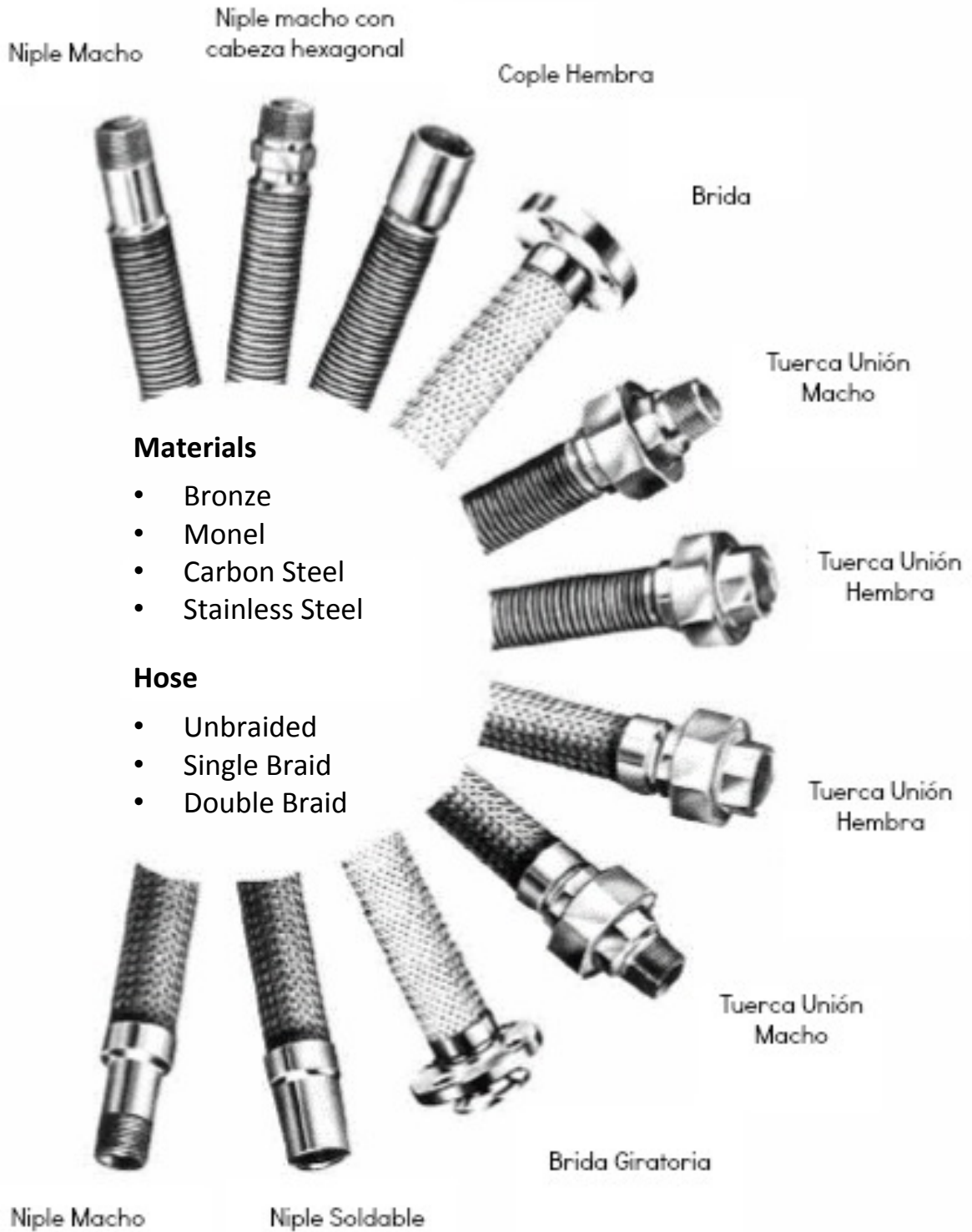







Made of stainless steel placed on both ends of the hose and whose function is to joint all components of the flexible metal hose, by the TIG welding process.

Hose fittings types



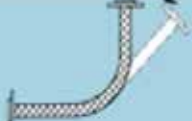
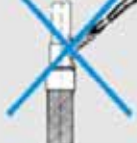











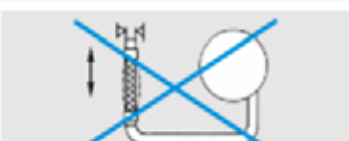
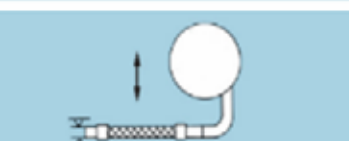

Installation

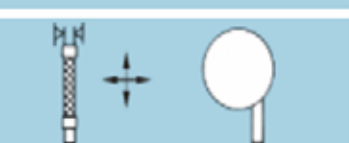





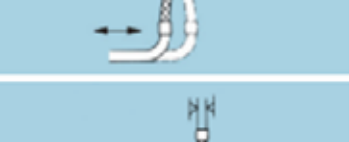



To guarantee correct functioning of the flexible metal hose it is important to take the following recommendations into account:

Incorrect position		Correct position
	<p>Do not bend with movements, but absorb movements only at the level of the flexion.</p>	
	<p>Do not bend excessively at the extremes of the hose, but divert with tube elbows.</p>	
	<p>Do not use just any length, but establish exact lengths.</p>	
	<p>Do not dimension too long, but establish exact length.</p>	
	<p>Do not bend wrongly, but bend without torsion at movement level.</p>	
	<p>Do not overheat joining cordons, but refrigerate and keep away from the hose's torch.</p>	
	<p>Do not drag over the floor without protection.</p>	

Installation

Incorrect position		Correct position
	<p>Do not install in displaced connections, without a level.</p>	
	<p>Do not bend excessively when hanging, but foresee a support for the hose.</p>	
	<p>Do not bend extremes excessively, without installing a rigid deviation.</p>	
	<p>Do not install axially, but vertically to the direction of the movement.</p>	
	<p>Do not movements from several directions with one hose, but with a elbowed hose.</p>	
	<p>Do not divert to one side, but dispose centrally.</p>	
	<p>Do not allow axial movements, but foresee the installation vertically to the hose's axle.</p>	
	<p>Do not foresee big lateral movements, but the installation of a 90° elbow.</p>	

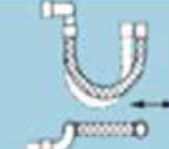
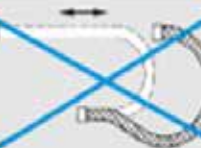
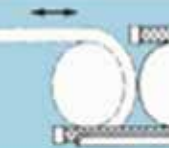
Installation

Incorrect position		Correct position
	Do not pull, unroll.	
	Do not bend, install without torsion.	
	Do not use a short hose, install with the correct length.	
	Do not bend excessively, without installing elbows as deviation.	
	Do not move crosswise through levels, only trough one level of the installation.	
	Do not allow to bend under own weight, unless supported by a base.	
	Do not install straight, but in U form.	

- Contact our support team for more information.

Asymmetrical Expansion Joints

Hoses are also used in the manufacturing of earthquake-proofed joints at to compensate the external movements caused by an earthquake. They offer safety and protection to the equipment and pipe system.



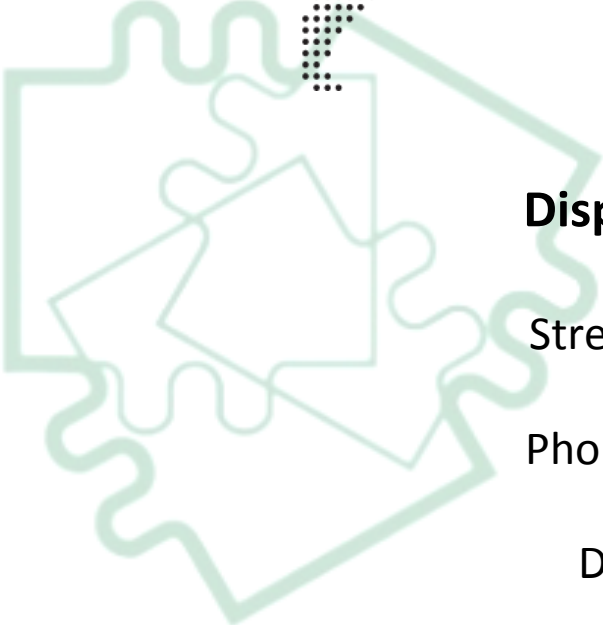

Dispositivos Flexibles S.A. de C.V.

Street 1 Norte, No. 3 Col. Atenatitlan,
Jiutepec, Mor. México C.P. 62572
Phone: 01(777) 319 45 06 / 320 5767
Fax: 320 2680
Dispositivosflexibles@hotmail.com
www.dispoflex.com.mx